

The how-to magazine of electronics...

# ELECTRONIC<sup>TM</sup>

*Servicing & Technology*

JUNE 1986/\$2.25

Double trouble • Buying and fixing "as is"...

Replacement parts

Audio corner



**Digital scopes make  
troubleshooting  
easier**



# LEADER



## Sometimes it's hard to go back for a scope!

**60-MHz full-function field-service Attache Case Oscilloscope is so light and small it will be taken everywhere, every time.**

LBO-325 packs all the power and performance of a cumbersome, backbreaking, 60-MHz workbench oscilloscope into an easy-to-carry, ultra-compact, featherweight unit. Although its 3½-inch CRT is as big and clear as screens on large field-service scopes—LBO-325 weighs only 9 lbs. So it won't weigh field-technicians down, no matter how far afield they go! LBO-325 is so small it fits inside a 3-inch deep attache case with room to spare for a multimeter, service manuals and some tools. The ideal full-function scope for a cramped work area or crowded bench.

### Reduces the cost of service calls.

Time is money. A scope left in the vehicle takes time to retrieve. One kept in the shop causes repeat service calls. The LBO-325



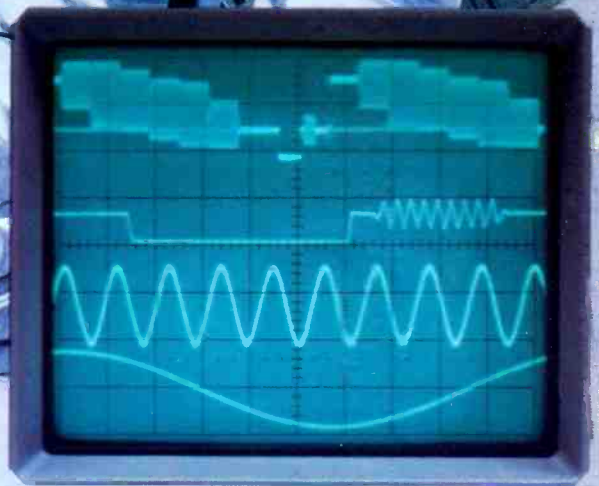
Attache Case Oscilloscope is so easy to carry and use, techs will take it everywhere, every time. And the time saved translates into extra profits for years to come.

### Outperforms all other portables:

- 60 MHz • Dual channel • ALT TIME BASE simultaneously displays main waveform and any expanded portion
- ALT TRIG for stable display of 2 asynchronous signals • Bright, sharp 12-kV trace • Large 3½-inch PDA CRT • Illuminated graticule
- Comprehensive triggering • TV-V and TV-H sync separators • Variable trigger hold-off • Delay line shows sharp leading edges • CH-1 output drives low-sensitivity instruments
- Measures only 3 x 9 x 11½ inches • Weighs 9 lbs.

### Two-year warranty.

Built tough to provide long use, LBO-325 is backed by Leader's 30-year reputation for reliability and by factory service depots on both coasts.



LBO-325 CRT is shown actual size.

Call toll-free  
**(800) 645-5104**  
In NY State  
**(516) 231-6900**

Request an evaluation sample, our latest Test Instrument Catalog with over 100 outstanding products, the name and address of your nearest "Select" Leader Distributor, or additional information.

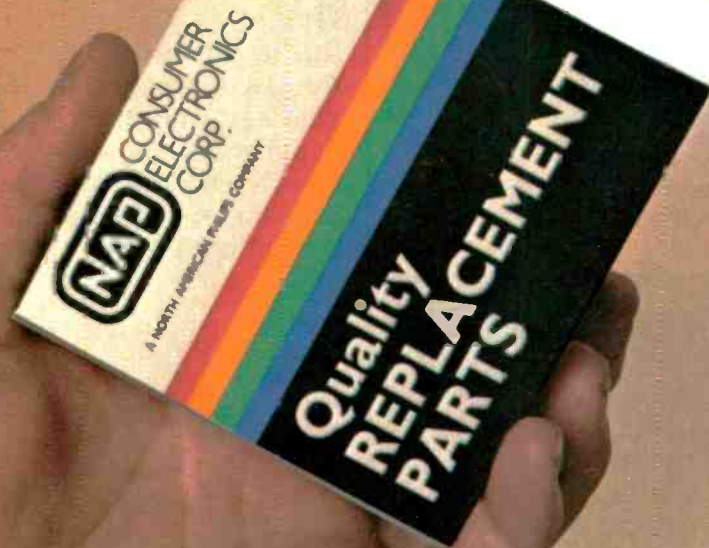
For professionals who know the difference.

**LEADER**  
Instruments Corporation

380 Oser Avenue  
Hauppauge, New York 11788  
Regional Offices: Chicago, Dallas  
Los Angeles, Boston, Atlanta  
In Canada call Omnitrion Ltd.  
(514) 337-9500

For Information Circle (1) on Reply Card  
For Demonstration Circle (2) on Reply Card

# Reach for the parts that earn their stripes.



Make it easy on yourself when you service Magnavox, Philco, and Sylvania sets. Reach for the parts that have earned their stripes.

N.A.P. factory authorized replacement parts make your job easier because they're specifically designed for N.A.P. sets. The reliability of N.A.P. parts is assured because they are engineered to meet exacting factory specifications for specific applications. And they're easy to get your hands on—readily available parts prevent unnecessary delays. N.A.P. parts are cost competitive and guarantee you the quality and service you demand.

When you reach for N.A.P. replacement parts, you reach for the best.

**SUCCESSFUL SERVICE SELLS**

Magnavox Philco Sylvania

N.A.P. Consumer Electronics Corp.  
Product Services Operation  
P.O. Box 309  
Greeneville, TN 37744-0309  
1-615-639-1121 Ext. 5833

A NORTH AMERICAN PHILIPS COMPANY

Circle (4) on Reply Card

# ELECTRONIC

Service & Technology

Volume 6, No. 6 June 1986

## 16

### Double trouble

By Homer L. Davidson

Tracking multiple problems in a TV receiver can mean a merry chase for the servicing technician; each obvious symptom may have been modified by those concealed malfunctions.

## 30

### Test your electronic knowledge

By Sam Wilson

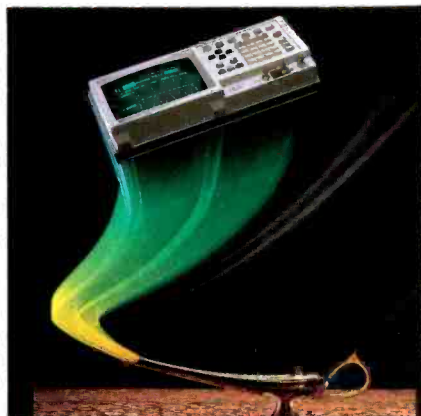
Once again, the author has based 10 questions on material that has appeared in recent issues of this magazine.

## 40

### Replacement parts

By Conrad Persson

Having identified the malfunctioning component, where is a suitable replacement? Not to worry!—this article includes a list of replacement parts firms for ready reference.



page 10

Digitizing oscilloscopes now are competitive to analog scopes. (Photo courtesy of Hewlett-Packard.)



page 46

If you found this at a bargain price, would you buy it?

## 46

### Buying and fixing "as is" electronic products

By Victor Meeldijk

Lives there a soul... who hasn't been lured to the bargain table in hopes of finding expensive equipment for cheap?? Read how to determine what to buy that's repairable.

## 54

### What do you know about electronics?—Temperature coefficients

By Sam Wilson

Roll your own, writes the author, who then proceeds to provide the equations you will need in designing to compensate for temperature changes.

## 64

### Audio corner

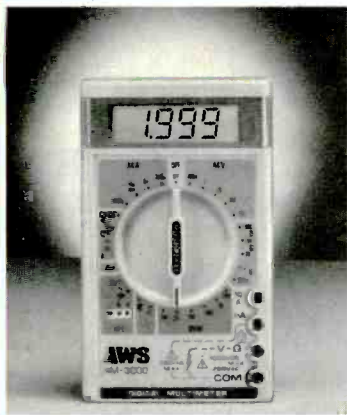
By Kirk Vistain

This new, monthly department begins this month with the author's assessment of audio equipment specifications.

## Departments:

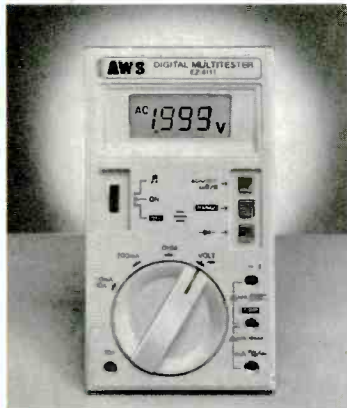
- 6 Editorial
- 8 News
- 10 Technology
- 31 Profax
- 58 Reader's Exchange
- 60 Literature
- 60 Books
- 61 Products
- 65 Photofact

# AWS MULTIMETERS



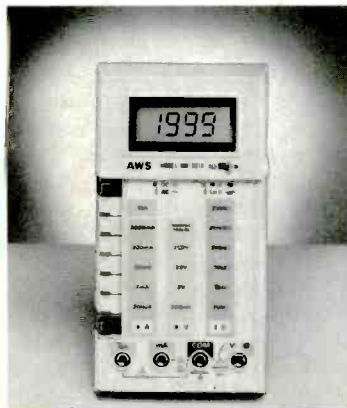
## DM-3000 3 1/2 DIGIT ROTARY SWITCH DMM

Just one of three DMM's in our Economy Series that combines quality with economy. Features include built-in HFE, battery and diode testing; conductance function; 300 hour battery life; 10Aac range; electronic overload protection on all resistance ranges; pocket-sized. (Also available models DM-1000 & 2000).  
**Ranges:** 0-200m/2/20/200/1000Vdc; 0-200m/2/20/200/750Vac; 0-200μ/2m/20m/200m/10Aac/dc; 0-200/2K/20K/200K/2M/20MΩ; 1.5V battery test; 0-1000 Hfe test; 2KΩ diode test.  
 DM-1000: \$39.95 / DM-2000: \$54.95 / DM-3000: \$69.95.



## EZ-6111 3 1/2 DIGIT AUTORANGING DMM

Unique and sophisticated in design, you'll find measurement taking a breeze. Loaded with features like autoranging in volts and ohms; manual range selection in all functions; diode test function, audible continuity indication; normal and low power ohm ranges; 10Aac/dc range; overload protection on all ranges; 300 hour battery life. **Ranges:** 0-200m/2/20/200/1000Vdc; 0-2/20/200/600Vac; 0-20m/200m/10Aac/dc; 0-200/2K/20K/200K/2MΩ; 0-2K/20K/200K/2MΩ LoΩ. \$99.95.



## DM-3010 3 1/2 DIGIT PUSH BUTTON DMM

The standard in tough, job-proven digital multimeters. Housed in shock resistant ABS plastic, you'll find safety was a prime design consideration. Also equipped with overload protection on all ranges; special electronic protection to 500Vac/dc on resistance ranges; UL1244 type test leads; normal and low power ohm ranges; 10Aac/dc range; auto zero and auto polarity; built-in tilt stand. **Ranges:** 0-200m/2/20/200/1000Vdc; 0-200m/2/20/200/750Vac; 0-200μ/2m/20m/200m/2/10Aac/dc; 0-200/2K/20K/200K/2MΩ. \$80.00.



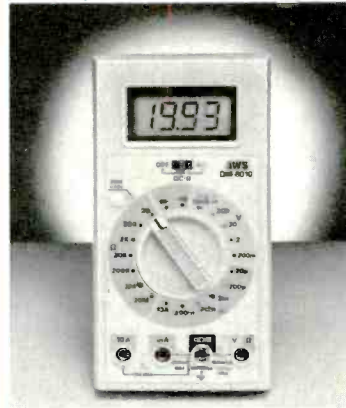
## DM-6500 3 1/2 DIGIT AUTORANGING DMM

This sensitive yet rugged instrument is loaded with features you'd expect to pay much more for. The 6500 offers autoranging; low battery consumption; fuse protection; safety test leads; audible continuity buzzer; auto zeroing; shock resistant housing. **Ranges:** 0-200m/2/20/200/1000Vdc; 0-2/20/200/600Vac; 0-200m/10Aac/dc; 0-200/2K/20K/200K/2MΩ. \$80.00.



## DM-7010 4 1/2 DIGIT ROTARY SWITCH DMM

High accuracy readings in the laboratory or in the field. Features include 4 1/2 digit 19999 max. display, built-in frequency counter to 200KHz and conductance function; 0.05% basic dc volts accuracy; overload protection on all ranges; special electronic protection to 250Vac/dc on resistance ranges; UL1244 type test leads; diode and continuity tests. **Ranges:** 0-200m/2/20/200/1000Vdc; 0-200m/2/20/200/750Vac; 0-200μ/2m/20m/200m/2/10Aac/dc; 0-200/2K/20K/200K/2M/20MΩ; 0-200nS conductance; 0-20K/200KHz frequency. \$170.00.



## DM-8010 3 1/2 DIGIT ROTARY SWITCH DMM

This easy to use DMM features a dc Volt accuracy of 0.25% of reading; overload protection on all ranges; special electronic protection to 500Vac/dc on resistance ranges; instant audible continuity buzzer; UL1244 type test leads; auto zero and auto polarity; diode test function; built-in tilt stand. **Ranges:** 0-200m/2/20/200/1000Vdc; 0-200m/2/20/200/750Vac; 0-200μ/200μ/2m/20m/200m/10Aac/dc; 0-20/200/2K/20K/200K/2M/20MΩ. \$84.95.



## DM-6592 ELECTRO-PROBE™ DMM

One of the smallest, most convenient hand-held DMM's you'll ever own. It's both autoranging and manual and is the perfect instrument for taking readings easily and accurately in hard to reach areas. Other features include instant audible continuity buzzer; one-hand operation; electronic overload protection on all ranges; data-hold button. **Ranges:** 0-200m/2/20/200/500Vdc; 0-2/20/200/500Vac; 0-200/2K/20K/200K/2000K/20MΩ. \$55.00.



## DM-1 POCKET-PRO™ DMM

Big features are packed in this pocket-calculator sized DMM. You'll find autoranging; electronic overload protection on all ranges; auto-polarity; audible and visual continuity indication; built-in test leads; "booklet-type" carrying case is designed to fit easily in shirt pocket. **Ranges:** 0-200m/20/200/400Vac/dc; 0-200/2000/20K/200K/2000KΩ; 0-200Ω continuity. \$29.95.

# A.W. SPERRY INSTRUMENTS INC.

For more information see your local distributor or contact A.W. Sperry Instruments Inc.  
 245 Marcus Blvd., Hauppauge, N.Y. 11788 • 800-645-5398 Toll-Free (N.Y. and Alaska call collect 516-231-7050).  
 Circle (5) on Reply Card

# Parts selection and handling

The process of servicing a faulty electronic product can be neatly broken down into a series of steps:

- Recognition that a problem exists
- Diagnosis of the reason for the problem
- Isolation of the problem to the component level
- Identification of the faulty part or parts
- Finding a source for replacements
- Procurement of the parts
- Proper handling and installation of the replacement part
- Testing the repaired unit
- Returning the unit to service

Ordinarily in *ES&T* we deal with diagnosing the problem—starting with circuit theory and going right through diagnosis of the problem, including isolation of the problem to the component level.

The difficulty of servicing frequently doesn't end with isolation of the bad component(s). Many times, once the faulty component is located, a new set of problems arises: how to identify the component, where to find a supplier.

This issue of *ES&T* is dedicated to helping you solve those problems. Articles in this issue deal with which semiconductor specifications are important, how to identify unmarked or poorly marked components, where to find replacements and how to handle them before and during installation.

One of the greatest difficulties in obtaining replacements is finding the right replacement. It's far easier in mechanical systems: With a good eye and some measuring instruments, you often can substitute a suitable alternative when an exact replacement can't be found. In fact, sometimes when you're trying to fix an inexpensive product, you can repair it so it's better than it was when it was new.

Take, for example, a product made of sheet metal. In many cases they are tack welded, and when stressed, the welds separate. I had a snow shovel like that once. In such a case, it's simplicity itself to drill a couple of holes, repair the break with nuts and

bolts and the repair is stronger than the joint was when the product came off the assembly line.

It's a lot less obvious when the product is a television or stereo and the problem is a failed transistor rather than a ruptured seam. But if you become familiar enough with component specifications in general and a specific electronic product in particular, you may find that sometimes when an exact replacement is not available, you can specify one with better specs and end up with a repaired product that's better than when it was new.

### Accent on audio

Beginning with this issue, *ES&T* will be featuring a new monthly department on audio, authored by Kirk Vistain. Kirk has written several articles for *ES&T* in the past, including two on servicing of video games and one on audio servicing. He has many years of experience on the audio servicing bench and as an audio servicing manager, and is now a service manager with a major electronics manufacturer.

The first two installments in this series, starting with the one in this issue, will be about audio specs, and will be followed in future issues by articles on microcomputers in audio products and signal tracing methods.

*ES&T* traditionally has emphasized TV servicing, and will continue with that emphasis. However, more and more people are buying an ever growing variety of electronic products: VCRs, compact audiodisc players, computers and more. And each generation of these products offers more features and is more complex and more difficult to understand and service than the preceding generation. For this reason we feel that it's imperative that we place greater emphasis on these products without sacrificing coverage of television. This monthly emphasis on audio is the first step in that direction.

*Nils Conrad Persson*

# If you can't fix your board with the enhanced 9000 Series, it's beyond repair.

## Introducing a new dimension of test capabilities for the Fluke 9000 Series Micro-System Troubleshooter line.

Finally there's a way to conquer some of the most difficult board testing problems imaginable. Take control of the situation with Fluke's 9000 Series and new **Asynchronous Signature Probe** option. You'll be able to pinpoint virtually every digital hardware fault on the entire board. Even those frustrating faults in circuits that operate independently of the microprocessor bus cycle.

Begin testing boards with the 9000 Series' built-in, preprogrammed test routines. In a single keystroke, you can automatically check the entire microprocessor kernel—Bus, ROM, RAM and I/O.

For testing beyond the bus, Fluke's new probe option eliminates the need for a logic analyzer or scope to test asynchronous circuits. One complete package, easily installed into either new or existing 9000 Series units, offers signature analysis, waveform capture and event counting. These three vital troubleshooting functions give any 9000 Series the power to diagnose:

- DMA Controllers
- Disk Controllers
- Video Controllers
- Video-Generation Circuits
- Communication Circuits
- Peripheral Controllers
- Dynamic RAM timing relationships

Not only does the 9000 Series test more of the board, it also supports more 8-bit and 16-bit processors than any other tester on the market.

Call Fluke toll-free **1-800-426-0361** or contact your local representative, and put your most challenging board to the 9000 Series test. If it can't be fixed with the enhanced 9000, it's probably beyond repair.

**FLUKE**®

Circle (6) on Reply Card

## Used computer listing service goes national

Because of wide demand, Comp-Used, which has helped buyers and sellers of used computer equipment in the Northeast for two years, is expanding its services.

Comp-Used is a listing service that facilitates the sale and purchase of used computer equipment. Anyone with equipment worth over \$100 can contact the Comp-Used computer to register the product for sale. Similarly, anyone in the market to purchase equipment can call the Comp-Used computer for information. Comp-Used connects the buyer and seller and they finalize the sale. When a transaction takes place, the seller pays Comp-Used a small commission; there is no charge to buy.

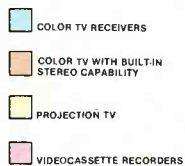
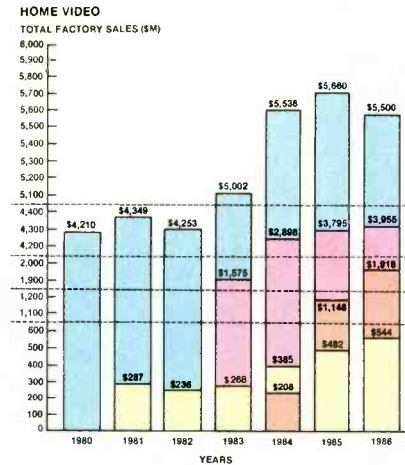
This service employs technology that allows most callers to be served by an automated telephone answering computer.

To talk it over with the Comp-Used telephone computer, call 203-762-8677.

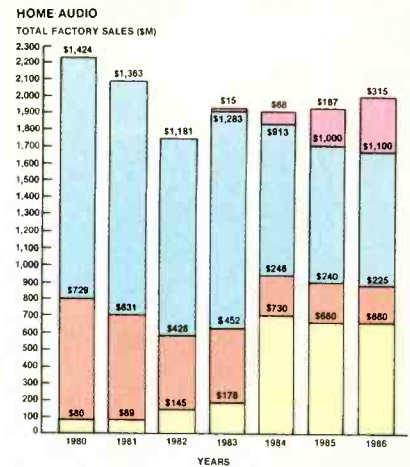
## Total factory sales of consumer video and audio products in millions of dollars (1981 through 1986 estimates)

These figures are based on sales through 1984 as documented by the Electronics Industries Association Marketing Services Department in its published statistics. The projected sales for 1985 also are based on EIA Marketing Services statistics to date, adjusted for seasonal variations, and upon a consensus of various industry sources.

The estimated sales for 1986 are based on a consensus of industry sources collected by this same services department of the EIA.



1985 figures are projected; 1986 figures are estimated.



1985 figures are projected; 1986 figures are estimated.

In forthcoming issues of *Electronic Services & Technology*, we will provide additional information concerning the dollar value of sales, and household penetration, of other consumer electronics products.



# ELECTRONIC

*Servicing & Technology*

Editorial, advertising and circulation correspondence should be addressed to: P.O. Box 12901, Overland Park, KS 66212-9981 (a suburb of Kansas City, MO); (913) 888-4664.

### EDITORIAL

Nils Conrad Persson, *Editor*  
 Carl Babcoke, *Consumer Servicing Consultant*  
 Dan Torchia, *Group Managing Editor*  
 Marjorie Riggan, *Associate Editor*  
 Joy Culver, *Editorial Assistant*  
 Darryll Fortune, *Editorial Assistant*  
 Sondra D. Williams, *Editorial Assistant*

### CONSULTING EDITORS

Homer L. Davidson  
 Christopher H. Fenton  
 Bud Izen  
 Victor Meeldijk  
 Kirk G. Vistain  
 Sam Wilson

### ART

Kevin Callahan, *Art Director*  
 Tim Lynch, *Graphic Designer*

### BUSINESS

Cameron Bishop, *Group Vice President*  
 Eric Jacobson, *Publisher*  
 Greg Garrison, *Sales Manager*  
 Stephanie Fagan, *Promotions Manager*  
 Kelly Hawthorne, *Marketing Assistant*  
 Dee Unger, *Advertising Supervisor*  
 Karen Royall, *Advertising Coordinator*

### ADMINISTRATION

R. J. Hancock, *President*  
 John C. Arnst, *Circulation Director*  
 Jo Ann DeSmet, *Circulation Manager*  
 Dee Manies, *Reader Correspondent*



Member, Audit Bureau of Circulation



Member, American Business Press



Member, Electronic Servicing Dealers Association

ELECTRONIC SERVICING & TECHNOLOGY is the "how-to" magazine of electronics. It is edited for electronic professionals and enthusiasts who are interested in buying, building, installing and repairing consumer electronic equipment. This includes audio and video equipment, microcomputers and electronic games.

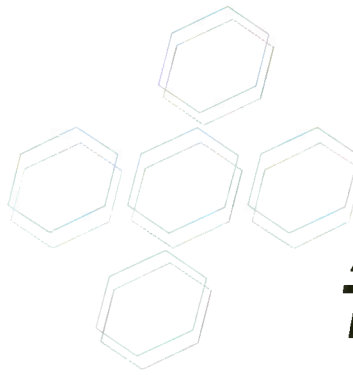
**SUBSCRIPTION PRICES:** one year \$18, two years \$30, three years \$38 in the USA and its possessions. Foreign countries: one year \$22, two years \$34, three years \$44. Single copy price \$2.25; back copies \$3.00. Adjustment necessitated by subscription termination to single copy rate. Allow 6 to 8 weeks delivery for change of address. Allow 6 to 8 weeks for new subscriptions.

**PHOTOCOPY RIGHTS:** Permission to photocopy for internal or personal use is granted by Intertec Publishing Corp. for libraries and others registered with Copyright Clearance Center (CCC), provided the base fee of \$2 per copy of article is paid directly to CCC, 21 Congress St., Salem, MA 01970. Special requests should be addressed to Eric Jacobson, publisher. ISSN 0278-9922 \$2.00 + 0.00



©1986 All rights reserved.





# Advanced Chemistry for Advanced Technology



Advances in engineering and design create constant challenges for the assembly, maintenance and repair of electronic equipment. To meet those challenges, Chemtronics is dedicated to providing you with only the finest, state of the art products. Each year, our R & D staff spends hundreds of hours testing and improving each product to ensure that your electronic components, systems and equipment perform at their designed rate of efficiency.

In production and rework... engineers depend on Chemtronics UL approved conformal coatings, QPL approved solders and masking agents, high purity degreasers, flux removers, anti-static sprays and non-contaminating desoldering braids. In field service... engineers and technicians depend on Chemtronics magnetic head/disc cleaners, non-residual wipes, foam swabs, dust removers, circuit refrigerants and contact cleaners.



**Chemtronics**

*Keeping pace with advanced technology.*

To help determine the Chemtronics products that are right for you, write us or call 800-645-5244, in New York 516-582-3322.

**Chemtronics Inc.**  
631 Old Willets Path  
Hauppauge, New York 11788  
Circle (7) on Reply Card



## Digital scopes make troubleshooting easier

Features such as infinite persistence, negative time measurement permit analysis not possible with analog scopes.

By Murray Haynes

In most applications, modern digitizing oscilloscopes perform as well as their analog counterparts, but offer some advantages, such as *infinite-persistence* displays and *negative time* measurements.

Single-shot writing rate is one of their weaker points, however. Here, analog scopes retain a clear edge and continue to do so until digitizing sample rates hit several gigasamples per second.

The analog approach is the only way to go when rise time must be measured in subnanoseconds. Above that, in the low nanosecond range, digital scopes provide strong competition because of recent advances in analog-to-digital (A/D) conversion.

The most important asset of a digital scope is the infinite-persistence feature, which allows a user to store a trace and display it for as long as is desired. The trace can be stored in memory for later retrieval.

Just as important, the infinite persistence of the display makes worst-case analysis possible. The average or single measurement is often not of interest—only the worst-case timing or noise-level condition may cause an error that

an engineer or technician may anguish over for hours or even days. With a digital-storage scope in the infinite-persistence mode, it's easy to see and measure worst-case noise, glitches, or timing errors (Fig. 1).

Some digitizing scopes also display extensive automatic pulse parameters on screen (Fig. 2). This feature can save time and greatly reduce an operator's measurement errors.

With an analog scope, it is not impossible on occasion to see worst-case conditions. Measuring them with any confidence, though, is hard because the phosphor latency of the CRT cannot keep the trace visible for long. Using a conventional mesh-type CRT storage scope doesn't help, because a normal signal's trace blooms (fades positive), again making the fleeting events almost impossible to see.

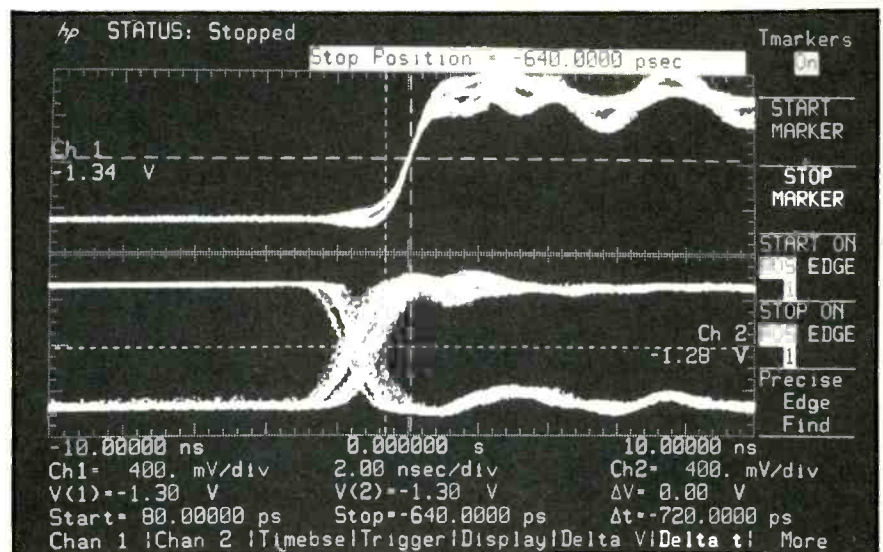


Figure 1. With a digital-storage scope in the infinite persistence mode it's easy to measure worst-case noise, glitches or timing errors.

Murray Haynes is Hewlett-Packard oscilloscope product manager.

### Catching up on single-shot

Recent improvements in A/D technology have helped close the gap between analog and digitizing scope single-shot measurement times. State-of-the-art A/D converters now can convert signals at a 200 megasample/second rate. In other words, the signal is sampled every 5ns and without further processing, provides a time resolution of  $\pm 5$ ns. That resolution still is not good enough for some critical oscilloscope uses. However, it can be greatly improved by some clever sampling methods.

Nyquist stated that when the signal sampled is band-limited to half the sampling rate (the Nyquist frequency), the original sampled signal can be reconstructed completely and accurately. That's the theory.

In reality, perfect band limitation is not achieved and frequency components above the Nyquist frequency *leak* through. These components are aliased, or transformed

into a lower frequency, much as in heterodyning, and this leakage limits the accuracy and repeatability of the measurements taken by a sampled data system. In addition, system non-linearities take their toll of accuracy.

Thus, though a 200MHz digitizer has a Nyquist frequency of 100MHz, it is better to limit the bandwidth of the input amplifier to about 60MHz. If that is done, signal components above 100MHz will be attenuated sufficiently for good reconstruction of the input signal.

Also, good design techniques are necessary to ensure both amplitude linearity and phase-response linearity. Good pulse-response characteristics require phase response to be linear. But that requirement is especially hard to satisfy beyond 50MHz, where the amplitude response has to roll off fast enough to suppress the frequency components above 100MHz. Even so, phase response

will remain linear above 50MHz if the filter in the passband of the oscilloscope is designed to have low ripple.

To help improve accuracy close to the Nyquist limit, the scope interpolates timing points between samples. This is done with digital filtering techniques having a repeatability of about 2ns. Two nanoseconds is about four times the time interval of the highest frequency of interest (60MHz) allowed to enter the scope's A/D converter. The repeatability is limited by the imperfect rejection of frequencies above 100MHz, by the resolution of the trigger interpolator and by the stability of the reference clocks.

Thus, a digitizing oscilloscope may sample only every 5ns and have a rise time of only, say, 7ns. But when it incorporates the techniques just described, it can make time-interval measurements on single-shot or low repetition rate signals with better than 2ns repeatability. The scope's rise time, although strongly affecting the accuracy with which the rise (or fall) time of the signal can be measured, tends to cancel out on edge-to-edge time-interval measurements.

### Random repetitive sampling

Another sampling technique, called random repetitive sampling, does much more than increase a digital scope's resolution. It also makes possible a number of digital storage scope features, the two most important of which are so-called negative-time measurements and very high time-base stability. The pseudorandom nature of this sampling technique also eliminates aliasing problems.

It is the sampling rate of a digital oscilloscope that determines its real-time bandwidth. An

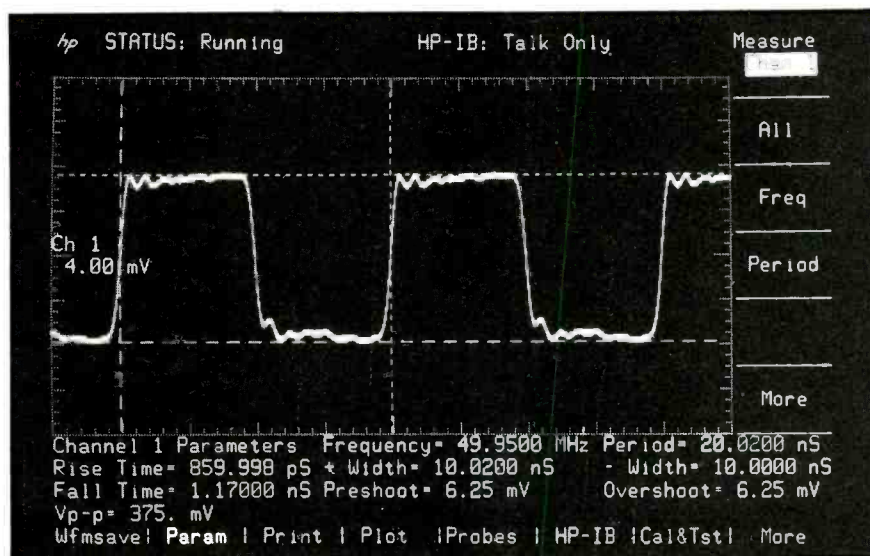


Figure 2. Some digitizing scopes also display extensive automatic pulse parameters on the screen.

A/D converter having many output bits can increase the resolution of the display's vertical axis (value being measured). But for high-frequency measurements, such a converter loses information along the horizontal axis (the time base) because it is generally slower than an A/D device delivering fewer output bits.

One way of overcoming this problem is to use the random repetitive sampling technique. As employed in the HP 54100A/D digital scope, it provides a 1GHz bandwidth at just a 40 megasample/second digitizing rate.

With random repetitive sampling, the sampling occurs independently of the phase of the input signal. Nevertheless, the sampling timing is precisely controlled by a crystal-referenced clock, and samples are taken repeatedly, every 25ns or so, over many input-signal cycles.

This method of sampling is called *random* because there is no

correlation between the time when a sample is taken and the time when the input signal or the trigger pulse is generated from it during each signal cycle. It is called *repetitive* because the process repeats continuously to build up a picture of a waveform from the many randomly spaced samples that are superimposed on a single display sweep.

Obviously, if the display sweep speed is slow compared to the sampling rate, a very complete record of the waveform is obtained (Fig. 3). But obviously, too, the time needed to accumulate the samples is being traded for the increased resolution—in effect meeting Nyquist's criterion for accurate signal sampling.

When a trigger pulse is generated, a precise time measurement is made between the next sample and that trigger pulse. Once the time of one sample has been referenced, the time of all other samples in memory for that

signal cycle is known, because the sampling frequency is known to great precision. This time measurement then is used to assign each voltage sample (for that signal cycle only) to a time coordinate relative to the trigger.

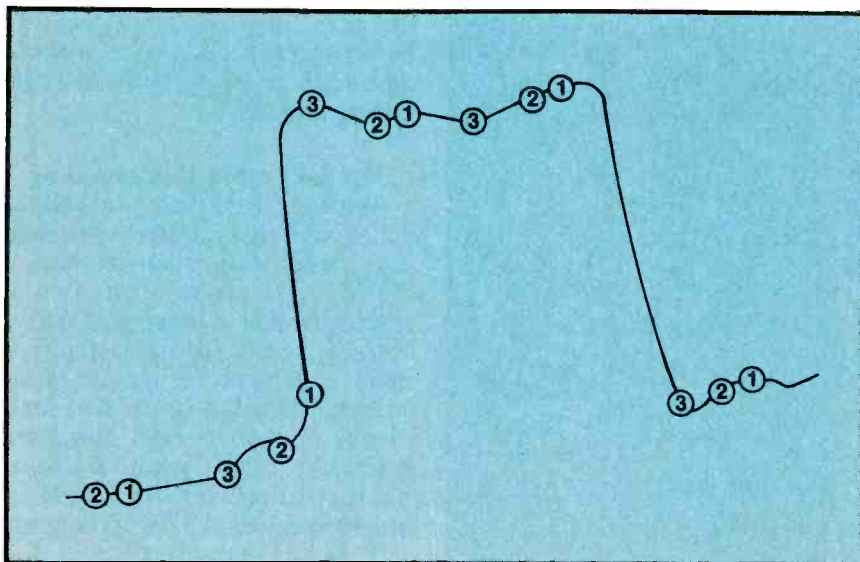
If the time coordinate of the sample falls within the displayed window, as determined by the settings for sweep speed, delay and reference location, a dot lights up on the screen at that point. But if the window is missed, the sample is ignored.

#### Negative time

Random repetitive sampling allows the user to look at events that occur before the trigger (in "negative" time). In many cases, that capability is vital to the ability to find the cause of a problem or to obtain important data (Fig. 4). Other digitizing techniques are limited to one screen diameter of negative time, whereas random repetitive sampling can look thousands of screen diameters back in time.

Random repetitive sampling also can enhance digital scope performance by providing exceptional time-base stability. If the time-base jitter was many times the resolution and differential accuracy, it would be meaningless to make measurements with a 10-ps resolution at a point far distant from the trigger point. But in fact, the crystal-controlled sampling clock of the digital scope can provide stable timing having short-term phase noise, or jitter, of less than half a part per million. That is several orders of magnitude better than the stability of the usual analog oscilloscope time base.

To understand the implications of this degree of stability, consider a high-resolution graphics display of 1,000 x 1,000 lines, where one pixel occupies 1/1,000,000 of the



**Figure 3.** If the display sweep speed is slow compared to the sampling rate, a complete record of the waveform is obtained.

**Simpson Electric Co.**  
Introduces

# mercer

## The Ultimate in Low-Cost Test Equipment

At last! Here is your opportunity to take your pick from a new test equipment line that has all the features you need and more... and at a price that is unbelievably low.

**MODEL 9340**  
Pocket size, 3½-digit  
DMM with 20 megohm  
range and 10 megohm  
input resistance  
\$44<sup>00</sup>

**MODEL 9670**  
Digital capacitance  
tester covering 0.1 pF  
to 20,000 µF  
\$99<sup>00</sup>

**MODEL 91C1**  
Compact VOM with 27  
ranges, including a  
100 megohm range  
\$29<sup>00</sup>

**MODEL 9301**  
3½-digit, hand-held  
DMM with 0.25%  
basic accuracy and  
2,000-hour battery life  
\$69<sup>00</sup>

**MODEL 9120**  
Analog VOM with 12 A  
DC range and output  
jack  
\$39<sup>00</sup>

**MODEL 9401**  
4½-digit, full function,  
hand-held DMM with  
.05% accuracy and  
data hold  
\$129<sup>00</sup>

**MODEL 9701**  
digi-clamp™ compact  
AC clamp-on volt-ohm-  
ammeter with data hold  
\$69<sup>00</sup>

**MODEL 9370**  
3½-digit autoranging  
DMM with a memory  
mode and 0.5% basic  
DC accuracy  
\$59<sup>00</sup>

# mercer

**ELECTRONICS**

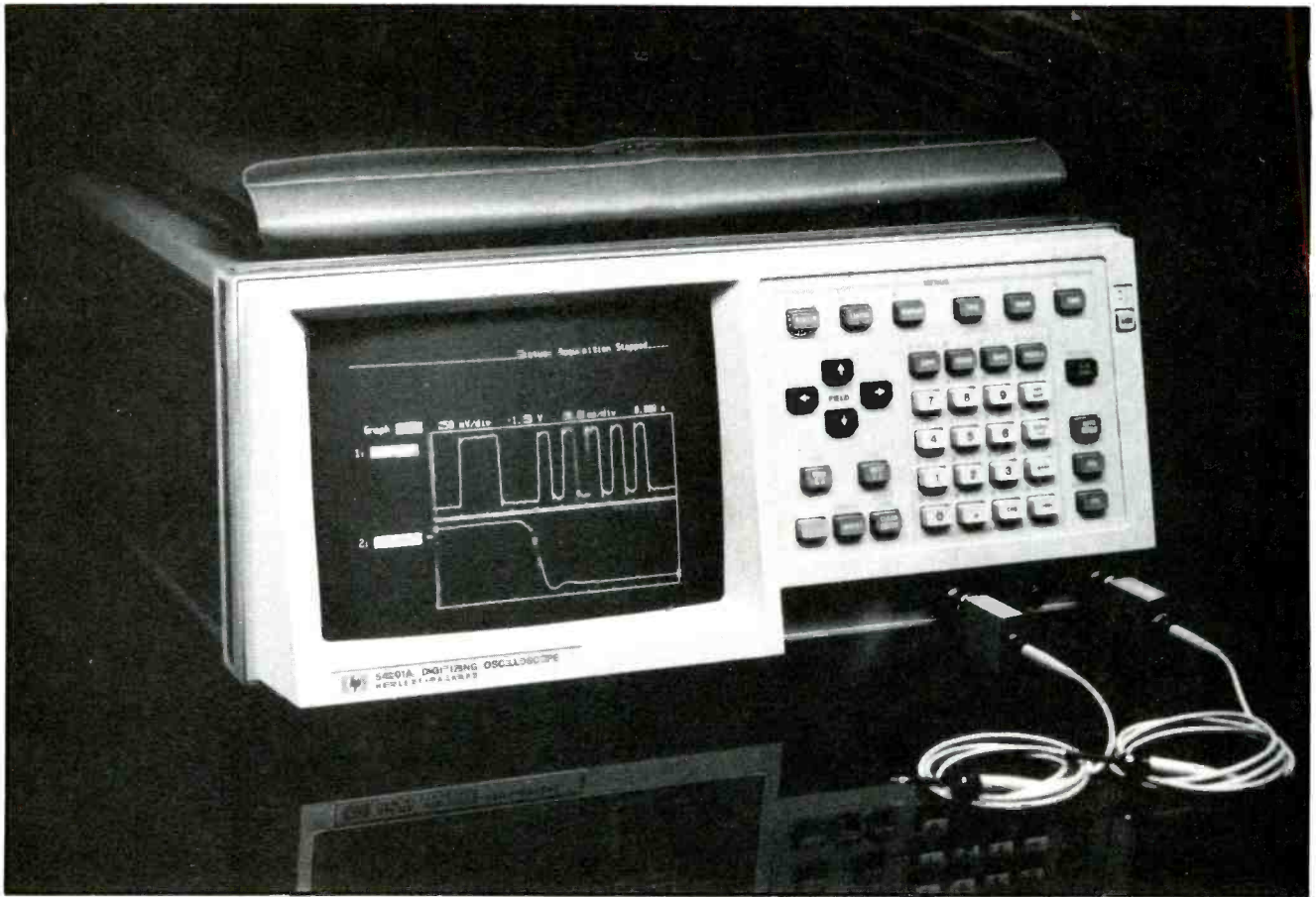
Division of Simpson Electric Company

859 Dundee Avenue, Elgin, IL 60120-3090  
(312) 697-2265 • Telex 72-2416

Mercer Electronics products reflect the design and quality standards established by Simpson Electric Company, an industry leader for over 50 years and known worldwide for its integrity and product excellence.

**In Stock... Available Now!** Stop in at your nearest distributor and see this new, complete line of Mercer test instruments. For the name of the MERCER distributor in your area, call (312) 697-2265, or send for our new line catalog.

Circle (8) on Reply Card



total frame time. After the scope had triggered on the start of a frame, the time-base jitter in an analog oscilloscope would be so great that the timing information on any pixel would be completely lost. With random repetitive sampling, a digitizing oscilloscope

could make a meaningful measurement of the jitter on a single pixel.

#### Eliminating the alias

Random repetitive sampling also is almost totally insensitive to aliasing. If a scope samples a signal at a frequency lower than

the signal frequency, the relative phase difference between the sampling and the signal frequencies could, of course, be close to an integral number of periods of the signal. The coincidence is an unlikely one. Nonetheless, if it occurred, the resulting small phase shift from sample to sample could yield an incorrect reconstruction of the signal.

In general, however, the sampling rate of an oscilloscope using random repetitive sampling is not correlated to the input signal frequency, and there is a random phase relationship between the sampling and the input signal. Accordingly, the probability is high that aliased data will be displayed on only one acquisition (one sweep). On succeeding acquisition cycles, the phase will be different enough not to be displayed (dots will not be lit).

Also, to further reduce the risk of aliasing on signals that might be an exact multiple or submultiple of the sampling frequency, the phase of the sampling clock can be randomly shifted, deliberately, between acquisition cycles.

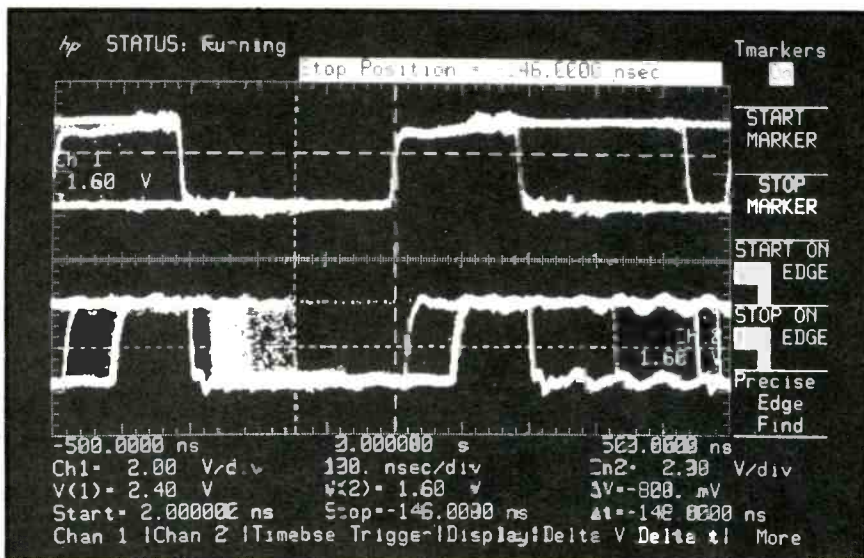
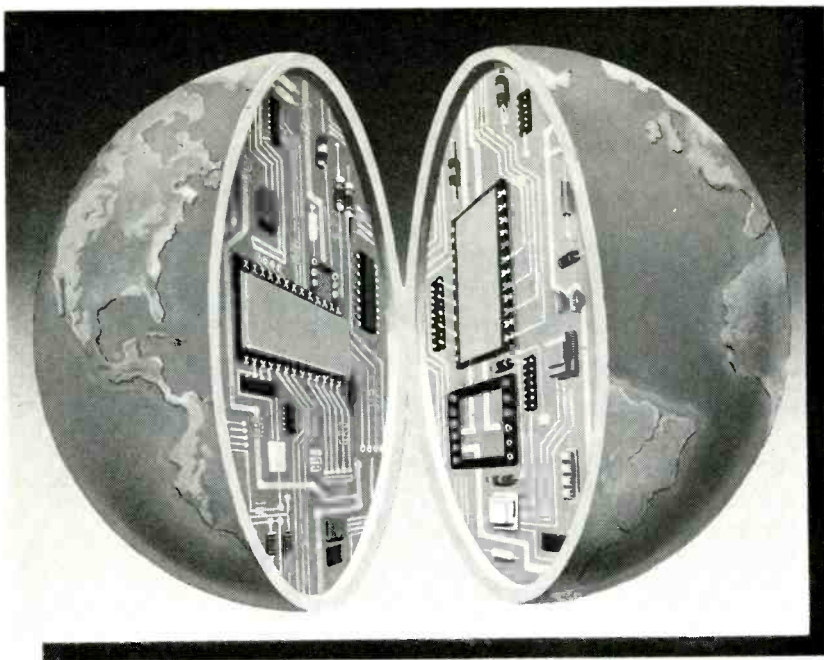


Figure 4. Random repetitive sampling allows the user to look at events that occurred before the trigger.



# CIE MAKES THE WORLD OF ELECTRONICS YOURS.

Today's world is the world of electronics. But to be a part of it, you need the right kind of training, the kind you get from CIE, the kind that can take you to a fast growing career in business, medicine, science, government, aerospace, communications, and more.

## Specialized training.

You learn best from a specialist, and that's CIE. We're the leader in teaching electronics through independent study, we teach only electronics and we've been doing it for over 50 years. You can put that experience to work for you just like more than 25,000 CIE students are currently doing all around the world.

## Practical training.

You learn best with practical training, so CIE's Auto-Programmed® lessons are designed to take you step-by-step, principle-by-principle. You also get valuable hands-on experience at every stage with sophisticated electronics tools CIE-designed for teaching. Our

4K RAM Microprocessor Training Laboratory, for example, trains you to work with a broad range of computers in a way that working with a single, stock computer simply can't.

## Personalized training.

You learn best with flexible training, so we let you choose from a broad range of courses. You start with what you know, a little or a lot, and you go wherever you want, as far as you want. With CIE, you

can even earn your Associate in Applied Science Degree in Electronics Engineering Technology. Of course, you set your own pace, and, if you ever have questions or problems, our instructors are only a toll-free phone call away.

## The first step is yours.

To find out more, mail in the coupon below. Or, if you prefer, call toll-free 1-800-321-2155 (in Ohio, 1-800-523-9109). We'll send you a copy of CIE's school catalog and a complete package of enrollment information. For your convenience, we'll try to have a representative contact you to answer your questions.



ES-07

## CIE Cleveland Institute of Electronics

1776 East 17th St., Cleveland, Ohio 44114

YES! I want to get started. Send me my CIE school catalog including details about the Associate Degree Program. I am most interested in:

- |  |   |
|--|---|
| <input type="checkbox"/> computer repair     | <input type="checkbox"/> television/high fidelity service |
| <input type="checkbox"/> telecommunications  | <input type="checkbox"/> medical electronics              |
| <input type="checkbox"/> robotics/automation | <input type="checkbox"/> broadcast engineering            |
| <input type="checkbox"/> other _____         |   |

Print Name \_\_\_\_\_

Address \_\_\_\_\_ Apt. \_\_\_\_\_

City \_\_\_\_\_ State \_\_\_\_\_ Zip \_\_\_\_\_

Age \_\_\_\_\_ Area Code/Phone No. \_\_\_\_\_

Check box for G.I. Bulletin on Educational Benefits

- Veteran  Active Duty

**MAIL TODAY!**

**OR CALL TOLL FREE 1-800-321-2155 (In Ohio, 1-800-523-9109)**

Circle (9) on Reply Card

# Double trouble

Sometimes a technician will find and correct the television malfunction, only to find a second or third unrelated defect. Here are some examples and suggestions.

By Homer L. Davidson

Two or more malfunctions in different areas of the same color-TV receiver can provide a technician with more *challenge* than he wants or needs. These multiple-trouble units might have any of many possible combinations. For example, troubleshooting and repair of a non-working vertical-sweep circuit might produce a full picture, but one with excessive snow. Or a power-supply resistor is open, and although a new resistor appears to be the only component needed (because sound, picture and color now are normal), an intermittent short in a video stage might ruin the new resistor at any time.

Large numbers of components in many different circuits may be destroyed in any solid-state receiver when it has suffered lightning damage. Secondary arcs might have jumped across unpredictably between many points on the chassis (or inside ICs), resulting in damage in other than the obviously burned areas.

And the most unwelcome of all repair jobs is a television brought to you because a "technician" could not fix it, despite the replacement of many components (seemingly at random). Good advice: Before you can look or test for the original malfunction, check every replacement made by your predecessor to make sure that some of his work hasn't introduced problems. Check first the component value and specifications and then the soldering, along with any unwanted short circuits (or open circuits) from poor soldering. Only after you have verified those things plus

whether or not the components are connected to the correct spot should you begin normal troubleshooting. These receivers might require five or six separate repairs.

The following examples are typical of the many multiple-problem repairs I have encountered during recent years.

## **Receiver dead; then no vertical sweep**

When first powered-up, this RCA CTC120-chassis color receiver had no raster, no sound and no response to the remote control.

Because these symptoms often indicate low-voltage or line-rectified power failures, we checked the four bridge diodes in-circuit and replaced the open 5A F101 line fuse. Finally, the power loss was traced to failure of the power relay on the control module. Actually, the relay was normal, but the control circuitry was not activating the coil, so the contacts could not close. Therefore, no ac power was sent to the receiver power-rectifier and its supplies. Because we did not have the proper MCR016RA control module in stock, we added a temporary jumper across the



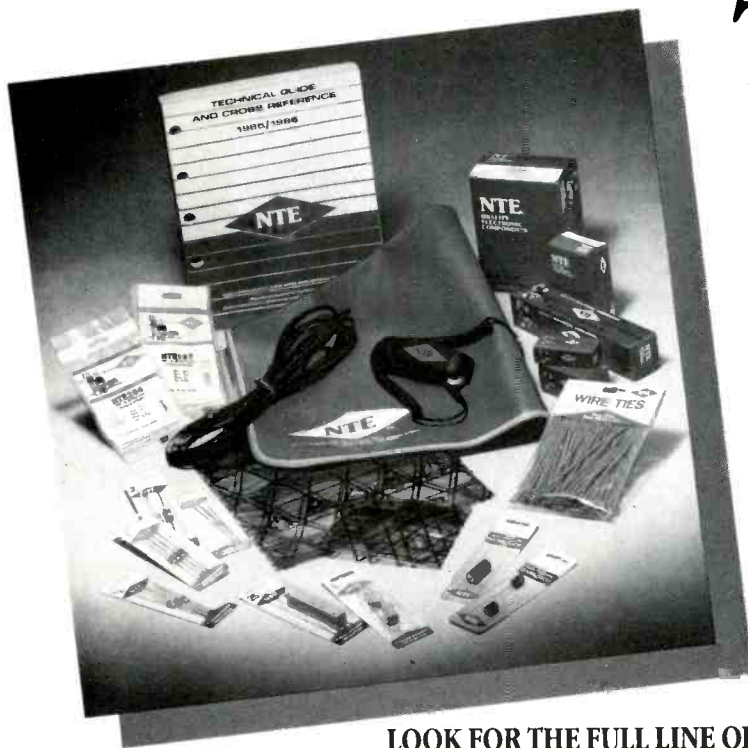
A TV technician is checking components that might have been damaged by lightning. Notice the large blackened area on this RCA circuit board. Individual defective components can be replaced, of course, but a circuit board that is badly carbonized over a large area calls for a new circuit board or discarding the entire receiver because of the huge costs involved.



We didn't get to  
 be the fastest  
 growing  
 semiconductor  
 replacement  
 line by making  
 light bulbs,



TVs and  
 radios.



In fact, semiconductors and components are our only business! So, all of our resources and energy are committed to giving you the highest quality replacement products and the best possible service.

You'll find our quality parts and products in bright green polybags and cartons at your local NTE distributor. Call or write us today for your copy of our 1985/86 Technical Guide and Cross Reference manual. It lists over 3,200 NTE types cross-referenced to more than 220,000 industry part numbers.

**LOOK FOR THE FULL LINE OF  
 QUALITY NTE REPLACEMENT PARTS AND PRODUCTS:**

- Transistors
- Thyristors
- Integrated Circuits
- Rectifiers and Diodes
- High Voltage Multipliers and Dividers
- Optoelectronic Devices
- Zeners
- Microprocessors and Support Chips
- Memory ICs
- Thermal Cut-Offs
- Bridge Rectifiers
- Unijunctions
- RF Transistors
- Microwave Oven Rectifiers
- Selenium Rectifiers
- Flameproof Resistors
- Wire Ties
- Electrolytic Capacitors
- Static Control Products

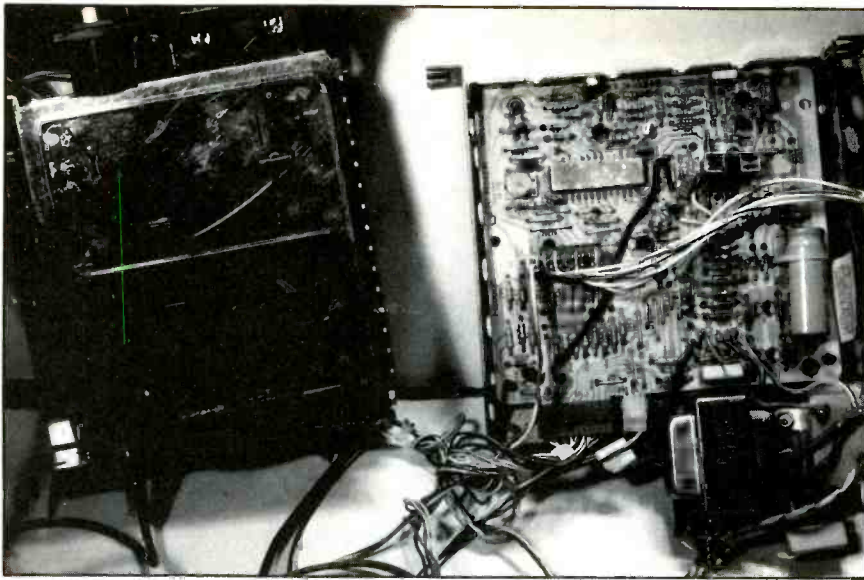


**NTE ELECTRONICS, INC.**

44 Farrand Street, Bloomfield, New Jersey 07003  
 (Outside N.J.) 1-800-631-1250 • (N.J. only) 1-800-624-2624

Circle (10) on Reply Card

GE is a registered trademark of General Electric.  
 Philips is a registered trademark of North American Philips.  
 RCA is a registered trademark of RCA Corporation.



Often the tuners and the control module are fastened together and mounted upright beside the horizontal TV chassis. A cable connects them to the chassis. The control module turns on the TV power via a relay and controls many TV functions.

relay contacts. Then sound and a raster consisting of one horizontal line in the center of the screen were obtained. There was zero vertical deflection. We decided to repair the vertical problem and then replace the defective control module when it was received later.

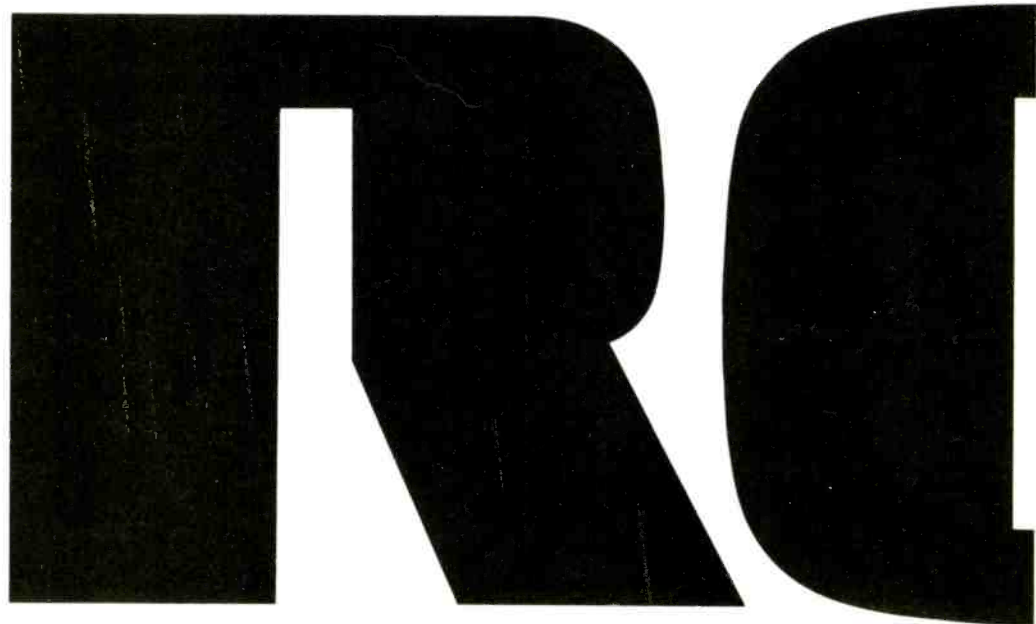
Using a digital multimeter, dc-voltage measurements were made at all leads of both vertical transistors. Only +3.3V was measured at Q501's collector where approximately +26V should have been. Q501 and Q502 tested normal in-circuit. Q501 was removed for

more accurate tests out-of-circuit, but the junction voltage drops and reverse leakages all were within tolerance (Figure 1).

Pin 18 of U401 deflection IC was scoped and the correct amplitude and approximate waveform was verified there. This ruled out incorrect base drive to vertical output Q502.

A hurried examination of the Photofact 2125-1 schematic appeared to show *all* Q501 collector voltage coming through 15k $\Omega$  R506 from the +118V source. However, another path from the Q501 collector passes through CR502 and 15k $\Omega$  R512 (with C506 as bypass or filter in parallel) to the +24.3V source. It is important to note that the diode polarity has its anode toward the +24.3V supply, so most of the +26.5V at the Q501 collector comes from +23.3V (24.3V minus 1V drop in CR502) with the remaining +3.2V being furnished by the 15k $\Omega$  R506 from the +118V source.

Next, we tested all vertical-sweep diodes in-circuit, finding none obviously defective. After



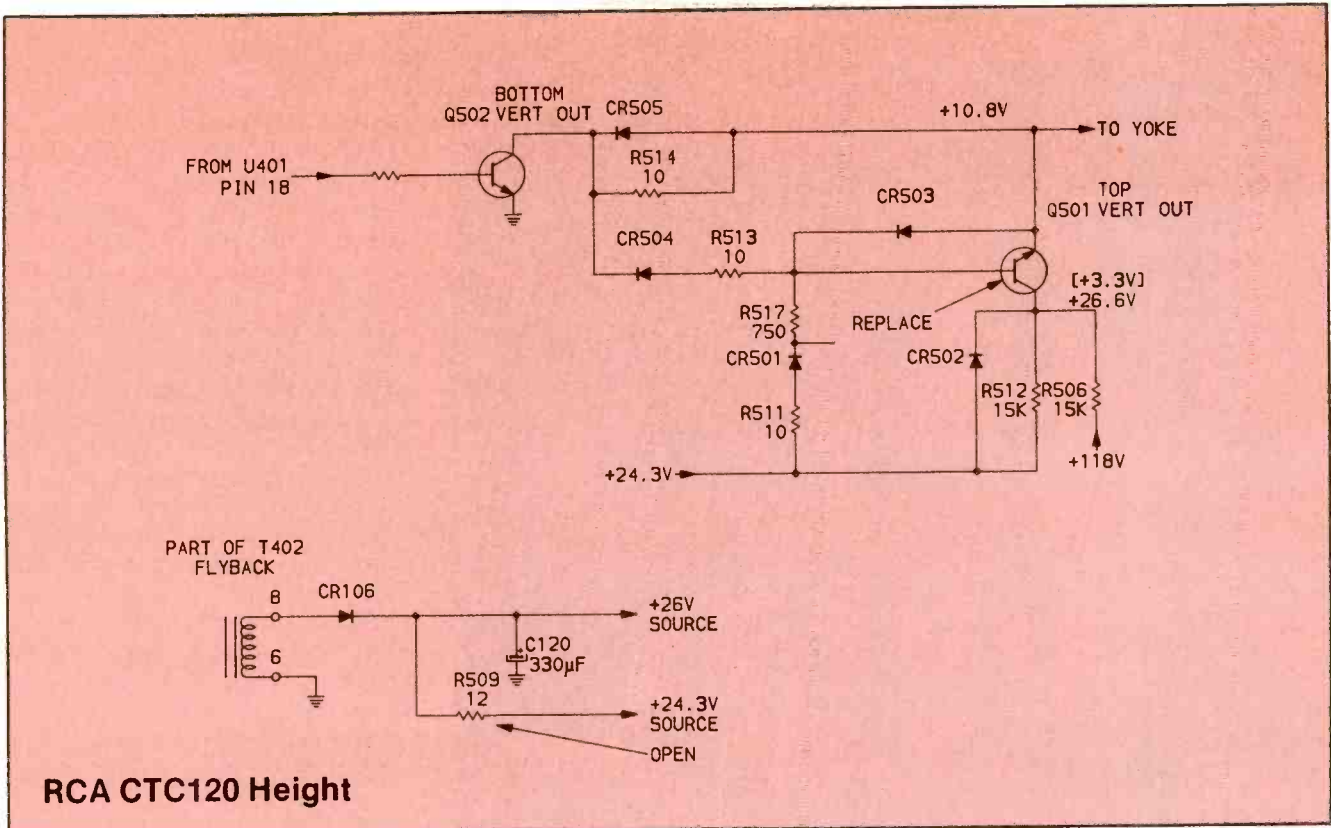
## The name that stands for more quality **Rep**

The odd component that some electronics distributors don't know anything about, your RCA distributor can find easily and supply quickly.

With RCA's central warehouse, which is as large as seven football fields, and has a standing, well-organized inventory of over 80,000 *different* products, you'll rarely be disappointed.

Not now, or later. Because the name RCA assures you and your customers of quality right down the line.

So try your RCA distributor next time you need an exact replacement part for the latest electronic wonder. Or any kind of tube (picture, receiving, broadcast, industrial). Or VCR part, SK solid state replacement (RCA stocks 2,500 kinds), video tape or accessory.



**Figure 1.** A loss of the +24.3V source voltage eliminated the vertical sweep and reduced the dc voltages at Q502 and Q501. An open 12Ω R509 in the power supply was responsible. The original defect was a malfunctioning tuner-control module that refused to activate the power on/off relay in this RCA CTC120 receiver.



# placements, Components, and Accessories.

We also provide free, convenient cross-reference books and manuals to help you find just what you need in a hurry.

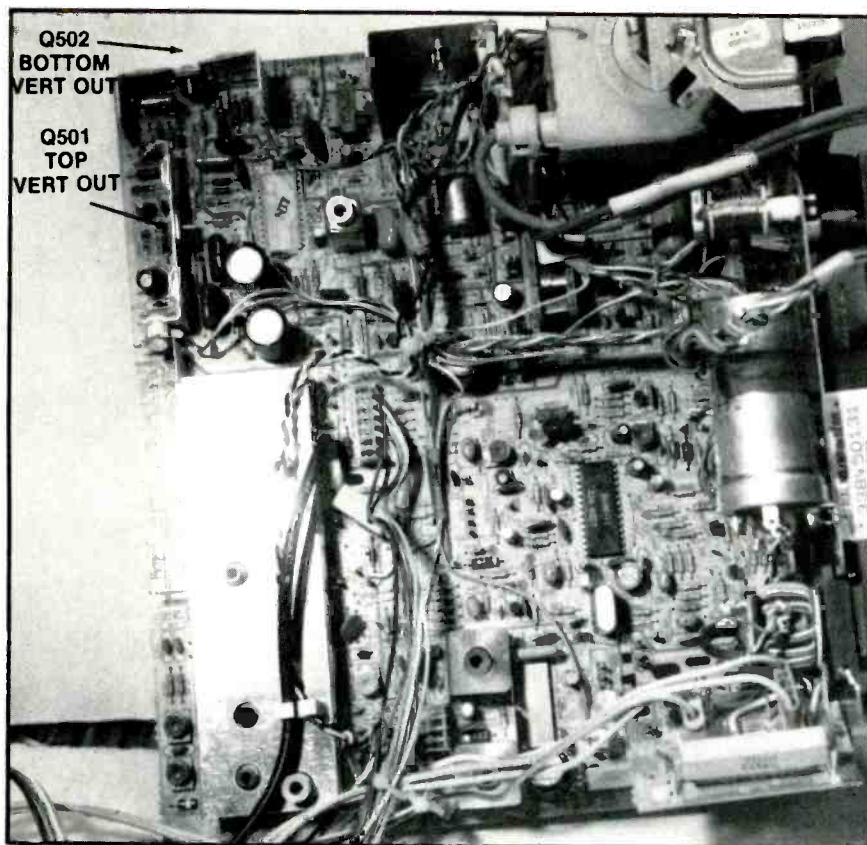
Just contact your local RCA distributor. Or write RCA Distributor and Special Products Division, 2000 Clements Bridge Road, Deptford, N.J. 08096-2088, ATTN: Sales Promotion Services.

And tell us which part of our name you're interested in.



**Quality right down the line.**

Circle (11) on Reply Card



Arrows point to Q502, the bottom vertical output transistor, on its heat-sink in the upper left corner of the photograph, and to Q501, the top vertical output transistor, on another heat-sink just below Q502 (in the photograph). This is an RCA CTC120 chassis.

that, one end of CR504, CR505 and CR502 was disconnected from each of its respective connections while the junction forward voltage drops and reverse leakages were accurately measured. All tested normal. But while working around CR502 and comparing its wiring against the schematic, we measured the B+ that should be there (+24.3V source) at the CR502 anode, discovering it was just a few volts instead.

Tracing the +24.3V source back to the rectified-flyback-power circuits, we measured a correct +26.1V at the +26V source from which the +24.3V source is taken through series resistance 12 $\Omega$  R509, as shown in Figure 1.

Replacement of the old R509 restored the vertical sweep. However, because Q501 was strongly suspected of arcing or otherwise erratically shorting and burning out R509, we replaced Q501 with the proper 153679 transistor to prevent a possible repeat of the problem.

After the tuner-control module arrived and had been installed, all functions of this RCA CTC120 receiver were operating correctly.

### Excessive brightness without control

The Wards model GGY16229A (Photofact 2170-2) showed two obvious symptoms: The brightness could not be turned down and the raster showed retrace lines. The visible video was weak with the appearance of AGC or other video-overload problems.

Because all three colors were present in the raster, defects in the color-output transistors were not likely. All CRT grid, cathodes, screen (G2) and focus voltages were within tolerance when measured at the picture-tube socket.

Next, the video stages were tested for dc voltages. During tests at and around Q904, the video driver, we noticed R920 was burned and measured out-of-tolerance. At Q904, the collector measured only +4.8V, the emitter +4.5V and the base about +4V. These readings left little room for doubt; Q904 must be leaky or nearly a dead short. After we removed Q904 from the circuit, the readings showed heavy leakage among all three elements. Although Q903 tested normal, we

decided it too should be replaced because it might have been subjected to considerable overload when Q904 shorted.

Replacing Q903 and Q904 with universal types and a new 47 resistor for R920 improved, but did not solve, the brightness problem.

No color could be seen in the picture, and no chroma waveforms were scoped at IC900, the auto video/chroma processor IC. Dc voltage measurements at the IC900 pins were either low or near zero. For example, IC900 pin 4 should measure +23.8V (from the +23.8V source) but it measured only +4.8V. This same +23.8V source also supplies B+ to the video transistors.

Voltage tests at the power supplies showed that the +23.8V source is taken from the +25V supply (through a resistor). Additional measurements proved the +25V supply also was very low, indicating defects in SC530 diode, C546 filter or the source of horizontal power. When one end of diode SC530 was disconnected from the circuit, allowing out-of-circuit tests, the diode was determined to be very leaky. (Remember, these diodes rectify 15,734Hz pulses. Therefore, all replacements should be *fast-recovery types* designed for operation at high frequencies.)

After an appropriate replacement was made for diode SC530, the +25V and +23.8V sources were restored but there still was no color. Several dc voltages at IC900 pins were low, especially those at pins 7, 8 and 9. An ECG822 universal replacement was installed for IC900, with normal color finally appearing.

In summary, repairs were necessary in three circuits to restore proper brightness and color in this receiver.

### No sound or raster

When first examined, the Sanyo 91C64 model (Photofact 1929-3) had an open F002 0.4A fuse, a leaky D001 line rectifier and an open 1.8 $\Omega$  R017 [the emitter resistor for the Q901 power regulator (Figure 3)]. After we replaced all these low-voltage power-supply components, the chassis would begin operation and then immediately go into shut-down.



In less time than it took you to read just the first ten words of this sentence - - -

You could have diagnosed any problem, in any brand, solid state TV set down to circuit level, with 100% accuracy.

By simply plugging the set's AC cord into a self programming Mark VII computer, pushing one test button, and noticing which one of sixty lights are lit.

The light that is lit tells you which circuit or stage is not functional.

In nine out of ten instances, you can do so without even removing the back of the TV set! (Talk about fast estimates)

**— INTERMITTENTS —  
NO PROBLEM WHATEVER!**

Leave the TV set's AC cord plugged into your Mark VII, leave the computer turned on, and go home for the weekend!

As soon as the set shuts down, or otherwise fails, the Mark VII will "Zero In" on **why** it failed, lite and latch the proper indicator light, automatically turn itself and the TV set off, then, sit there idle (with one light lit) awaiting your return.

**All this by just plugging in the AC cord.  
No other connections are required.**

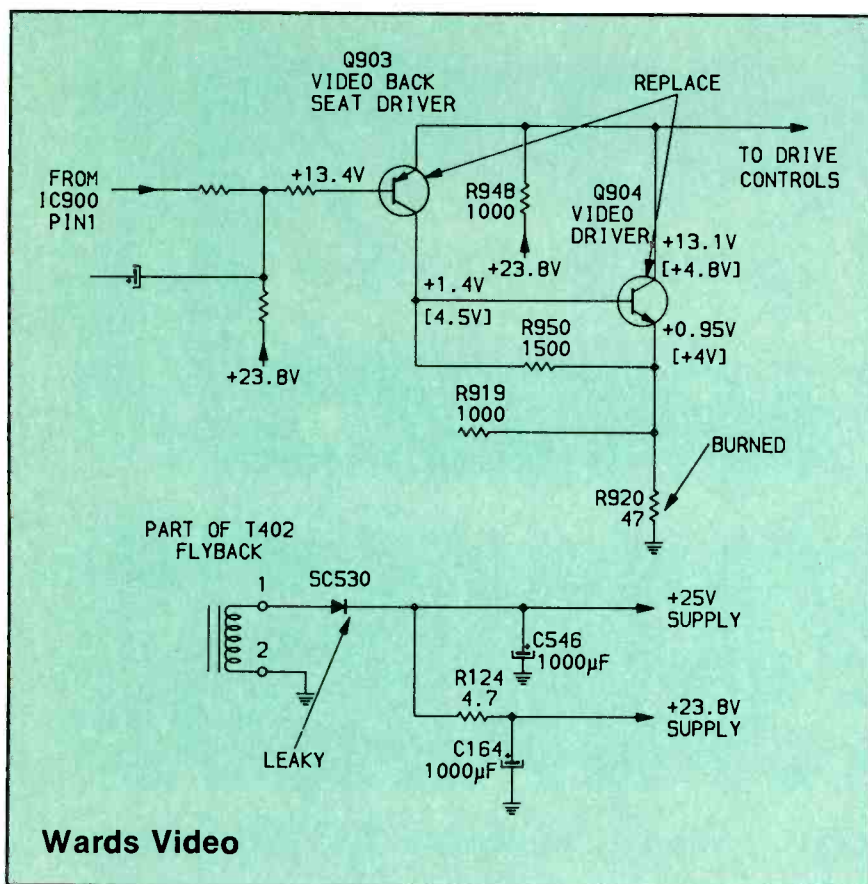
(In certain cases of low end, LV regulator shut down, you may have to bridge the LV regulator with an LV rect. other than this occasional inconvenience, no other connections are required. An adapter plug is provided for such instances.)

With a Mark VII you could accurately diagnose 400 TV sets down to circuit level in one 8 hour day. Unfortunately, you won't be able to replace the defective parts that quickly!

**DIEHL**

**Call (806) 359-0329 for more info**

6661 Canyon Dr. • Amarillo, TX 79110



**Figure 2.** Small defects can cause wild changes of dc voltages in direct-coupled video stages such as this Wards GGY16229A model, and the voltage changes produced excessive brightness. After the defective components shown in the schematic were replaced, the receiver produced B&W pictures, and it was necessary to replace IC900 to bring in the color.

To determine whether or not the problem was excessive high voltage at the picture tube, we plugged the chassis into a variable-voltage transformer and monitored the high voltage. When we increased the receiver ac only to 82Vac, the HV reached 28kV and the safety circuit produced shutdown. This proved the safety shutdown circuit was operating correctly, but did not show whether the low voltage or the high voltage was excessive. Certainly the dc HV was excessive for a line voltage of only 82Vac.

Next the line voltage was adjusted up to only about 78Vac or until the HV reached 26kV (which would not trigger the shutdown circuit). However, adjustments of VR001, the +120V regulated-voltage variable control, did not change the high voltage.

All the symptoms and measurements now indicated a loss of regulation in the +120Vdc supply, because the output of the regulator was too high even with reduced line voltage, and could not be changed by the VR001 variable

control. All resistors connected to IC101 were within tolerance, but many of the IC101 pins had excessive dc voltages. All these symptoms pointed to IC101 itself.

Replacement of IC101 and adjustment of VR001 +120V control solved the shutdown problem and gave normal operation.

But what caused R017 to open? Perhaps the sequence went something like this: IC101 became defective, increasing the Q901 base voltage and thus increasing the current drawn by the Q402 horizontal-output transistor so it blew fuse F002; then next time the receiver was turned on, Q901 was forced to carry all the overload current (normally R901 and Q901 are in parallel) which burned out R017 (1.8Ω), opening this last of the original two parallel paths and stopping all receiver operation.

**No operation—  
then unstable operation**

When the TR551 horizontal-output transistor and the F2 1.5A dc fuse were replaced in a JC Penney model 685-2041 (Photofact

1614-1), the picture and sound were restored. It seemed an easy repair, until I took a more critical look at the picture. Vertical lines were waving in the familiar pie-crust undulations.

In the past with other models, the pie-crust effect was caused by problems with B+ filter capacitors and electrolytics of the horizontal-deflection stages. Unfortunately, paralleling test capacitors across each large filter and the small electrolytics did not remove pie-crusting from the JC Penney's picture.

With older tube-equipped television receivers, insufficient filtering of the control voltage from the dual phase-detector diodes to the oscillator tube was the major cause of pie-crusting (usually a capacitor opened). Perhaps this also might apply to transistorized circuits. Rotating the horizontal-hold control slightly would shift the wiggles of the pie-crust, but not remove them. Scoping the sync showed nothing wrong, but the base of TR502 horizontal oscillator (Figure 4) had some fuzz mixed with the normal signal. All resistors of the phase detector and oscillator tested within tolerance. When another capacitor was paralleled across 3.3µF C507, all the pie-crusting disappeared. Replacement of C507 finished the repair, with the color receiver showing good pictures and producing normal sound.

It is likely the pie-crusting was present before the horizontal-output transistor shorted, but was not very noticeable because the wiggling became progressively worse as the electrolytic capacitor dried out gradually.

**No operation followed by arcing**

The 3A line fuse in a Sylvania E51-13 chassis was open. Its replacement blew instantly when ac power was applied next time. Tests showed the Q406 horizontal-output transistor was shorted, and it was replaced with a universal ECG238. Now the sound came on accompanied by the noise of high-voltage arcing somewhere. This arcing could not be seen. Although we suspected the flyback was arcing internally, there were no visible burned marks nor any hot areas around the windings.

Then we noticed the picture-tube heaters were not lighted (these are

# — NOTICE —

If your company is confronted with troubleshooting or otherwise repairing a certain type, or piece of equipment on a frequent basis - - -

i.e. TV sets, VCR's, Electronic Cameras, Copy Machines, Amplifiers, Industrial Controls, Answering Machines, Radios, Robotics, Bio Medical, Military, Avionics, etc., etc., etc., - - -

The odds are staggering that we could custom program one of our Mark VII computers to accurately isolate any failure in any such device (down to circuit level) in less than two seconds!

**INTERMITTANTS POSE NO PROBLEM**

(See our display ad on page 21)

***DIEHL***

6661 Canyon Drive • Amarillo, TX 79110

powered by a flyback winding). With the CRT socket removed, the heaters measured the normal resistance; they were not open. Also, *no arcing occurred* while the socket was removed although the normal 30kV was applied to the CRT anode button. These symptoms pointed to a picture tube, and a more careful visual inspection of the picture tube (after the power was switched *off*) revealed the CRT glass was cracked inside the yoke assembly. *The CRT had air in it*, which usually produces arcs inside the neck of the CRT. Of course, the picture tube required replacement.

### Main fuse blows repeatedly

Current-surge resistor R504 (2.7 $\Omega$ ) and 4A F1 line fuse were both open in a Wards GEN12965C (Photofact 2250-2). After they were replaced and the power switched *on*, the 4A fuse blew again. At first we suspected bad diodes in the bridge circuit, but all tested normal with the DMM except one that we replaced with a regular 3.5A diode. However, the 4A fuse blew after that.

Next, the horizontal-output transistor and the damper that is in the same case (as shown in Figure 5) were checked for shorts, but there were none. Yet even with the Q702

horizontal-output transistor out of the circuit, the fuse continued to blow.

When we checked the schematic we found a new kind of low-voltage regulator that is completely separate from the horizontal sweep and flyback. (I urge you to obtain Photofact 2250-2 and study these circuits in detail, checking against the following explanation.) Briefly, Q702 horizontal-output transistor drives the T702 flyback and the horizontal-yoke coils. In turn, the flyback supplies the high voltage, focus voltage, screen voltage and +200V for the color-output transistors, but *none* of the other low voltages. Q702 is operated from +105V that is regulated by the Q503 power-source output transistor (a de-voltage chopper) and its associated circuits. Q503 drives T504 with almost square waves of dc. T504 has five secondary windings producing four major dc voltage supplies after rectification and filtering (one is the regulated +105V for the horizontal-output transistor) plus seven other voltage sources taken from one of the other three. IC502 synchronizes the power-source regulator to the horizontal-sweep frequency, and it contains all the regulator solid-state devices (except driver Q502 and output Q503).

To recap: Conventional models have two main functions such as (1) LV rectification and regulation; and (2) horizontal sweep with HV and several LV power supplies that rectify horizontal power. The Wards TV also has two systems: (1) LV rectification and chopper regulation plus many LV sources powered by the regulator; and (2) horizontal deflection with HV plus two intermediate LV supplies.

A further search of the complete schematic showed that the T504 primary winding and Q503 were referenced to *hot* ground (notice the triangular symbol in Figure 5) while horizontal-output transistor Q702, rectifier D514 and all secondary windings of T504 return to *cold* ground, the same ground used for all TV signal circuits. In other words, T504 is the dividing wall between "hot" and "cold." Then we realized we were checking in the cold area for a hot short. Starting with the bridge rectifiers and its

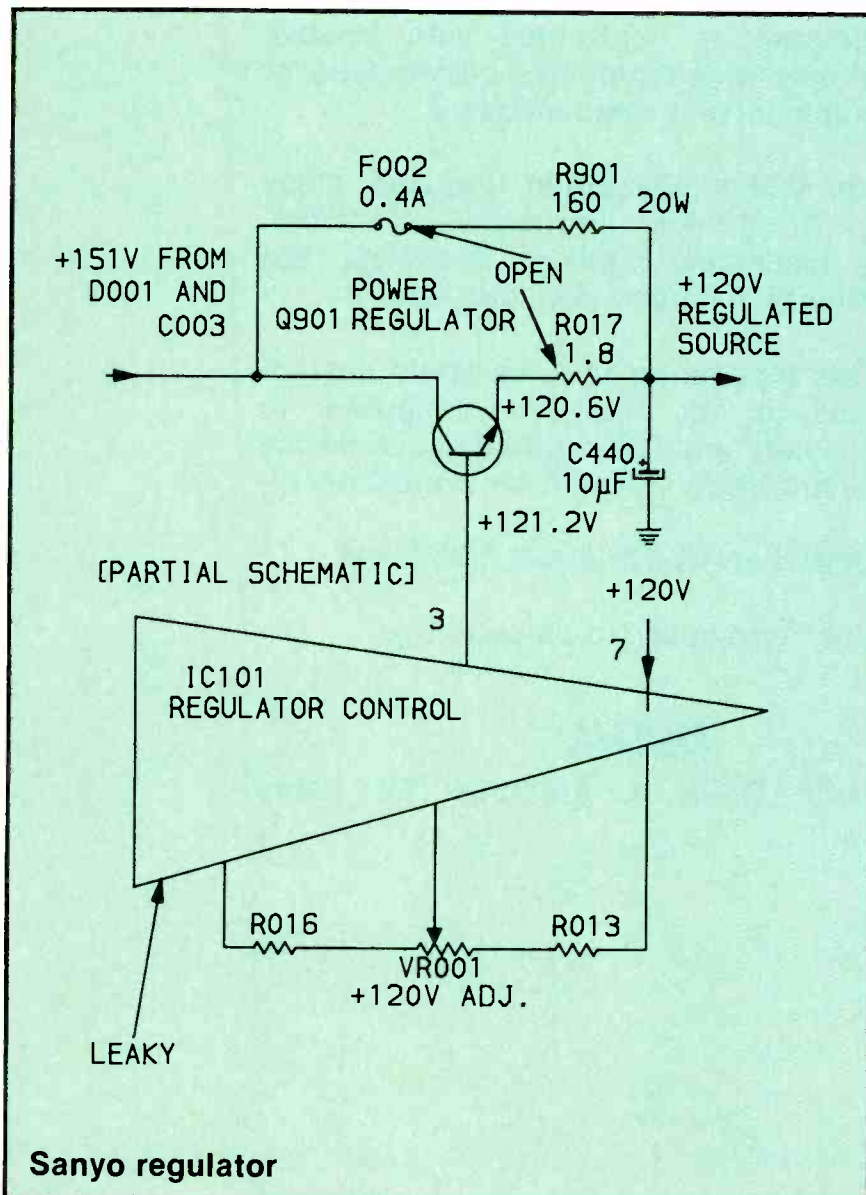


Figure 3. One component failed and that started a chain reaction requiring four new components in the Sanyo power-regulator circuit.



# WARRANTY WORK

When you compare time spent to pay received, you might find it difficult to survive on some of the warranty allowances in today's market.

If so, this ad will serve as a reminder - - -

In less time than it takes you to print the customer's name on a warranty tag, a Mark VII computer will diagnose the failure down to circuit level. In most cases it will do so - - - without even removing the back!

If your local factory field service representative says it can't be done, remind him that **Diehl** will pay any engineer / technician a year's wages who can troubleshoot just three of his most familiar TV sets, before a Mark VII can troubleshoot thirty!! Hopefully, this challenge will either cause him to take his foot out of his mouth, - - - or finish putting it in!

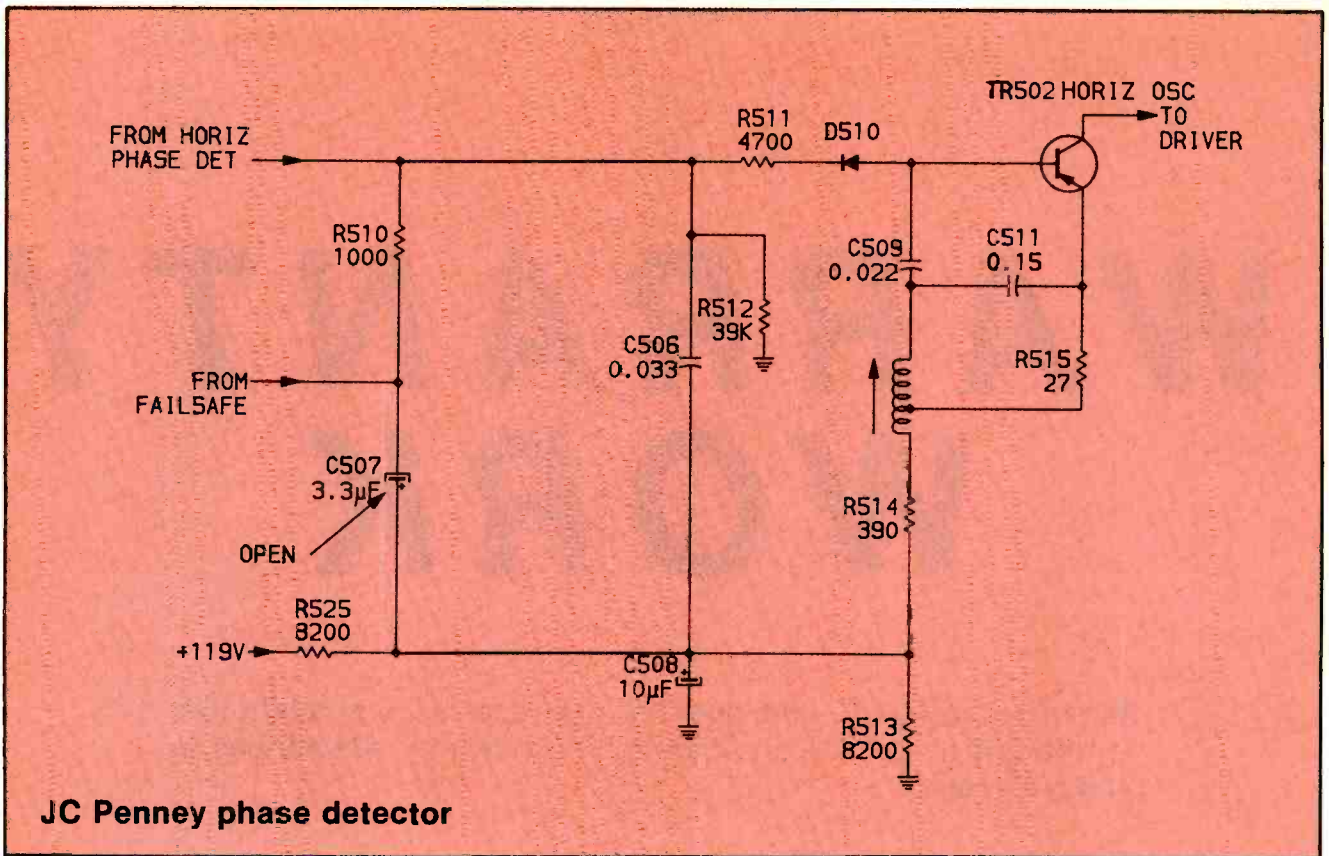
— INTERMITTENTS POSE NO PROBLEMS —

(See our display ad on page 21)

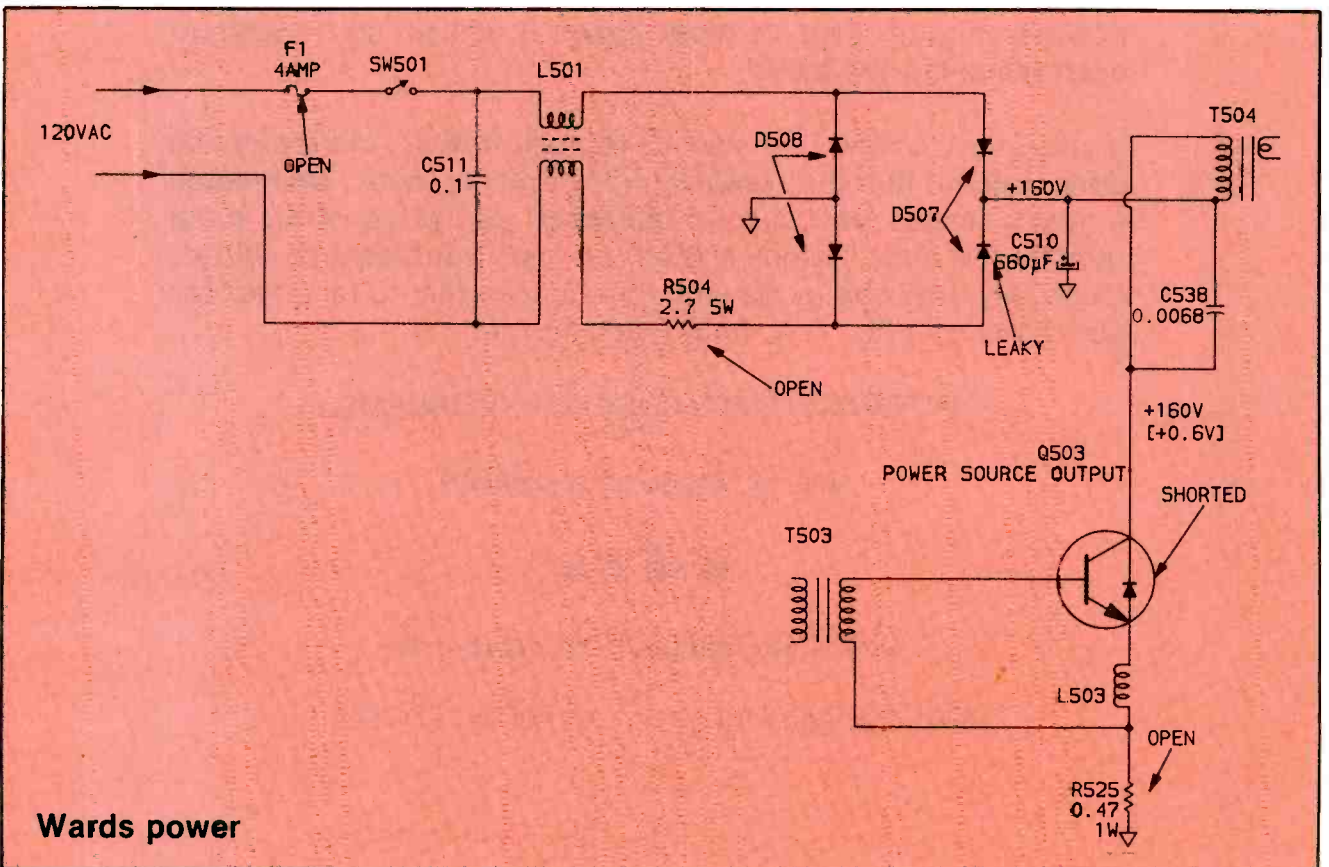
**DIEHL**

**Call (806) 359-0329 for more info.**

6661 Canyon Drive • Amarillo, TX 79110

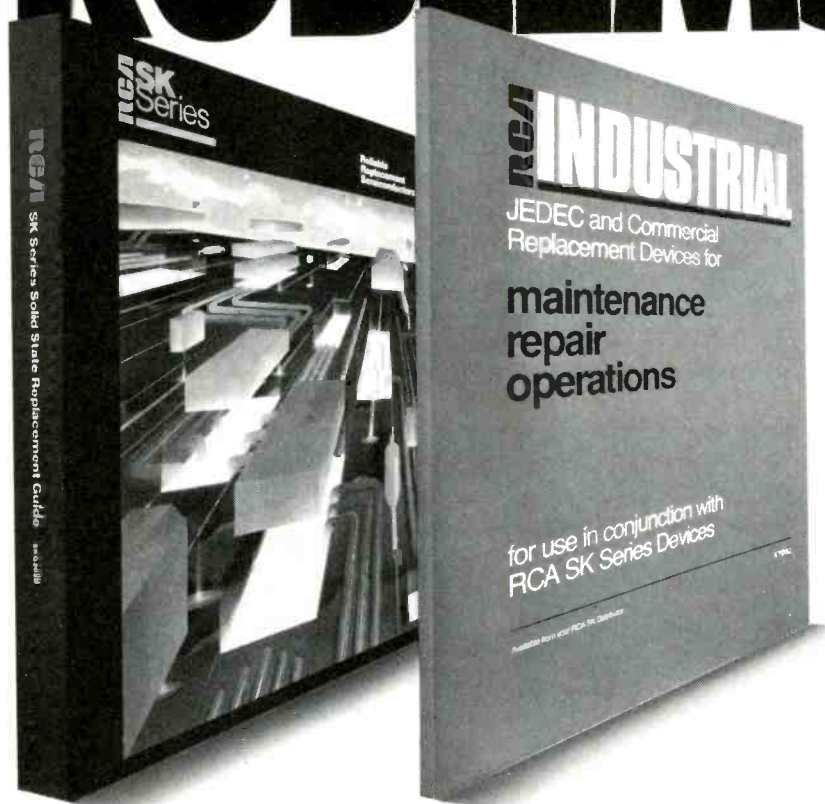


**Figure 4.** A dried-out C507 electrolytic in the JC Penny horizontal phase detector circuit caused pie-crusting. C507, in series with 1,000Ω R510 formed a long time constant to keep the control voltage constant over one vertical field (approximately).



**Figure 5.** Five components were replaced before the power supply and power-source regulator operated correctly. Complicating the analysis was the "hot" ground that is used for all circuits shown here, as vs. the "cold" ground used for the remainder of the circuits, including the horizontal-output stage. See the text for details.

# 2 SIMPLE SOLUTIONS TO 227,000 PROBLEMS.



RCA's SK Series Replacement Guide (SKG202D) is your one source for over 206,000 solid state replacements using 2,500 SK and KH types. Integrated circuits, thyristors, rectifiers, transistors, microprocessors — RCA has them all.

Likewise, RCA's Industrial MRO Guide (1K7862) lists over 4,000 devices that replace more than 21,000 JEDEC\* and Commercial types. The Guide also includes Power MOS/FETs, QMOS Integrated Circuits, a combined index/cross reference, and a section on high-reliability devices.

Together, these RCA Guides provide fast, easy answers for 227,000 solid state replacement problems.

For copies, see your local RCA distributor. Or write: Sales Promotion Services, RCA Distributor and Special Products Division, 2000 Clements Bridge Rd., Deptford, NJ 08096-2088.

\*Joint Electron Device Engineering Council

**RCA** SK Replacement  
Solid State

Circle (13) on Reply Card

almost dead short, we moved the probe to other points, finally locating the lowest hot reading at the Q503 collector. Yes, Q503, the power-source transistor, had a C/E short and a new 25C3156 was installed to replace it.

Now the Q503 collector should have tested +160V, but the collector measured about +167V, as did also the Q503 emitter because the burned 4.7Ω R525 had opened from the mechanical movements of installing the new Q503. Installation

of a new R525 brought normal operation after VR501 (+105V adjustment control) was rotated to provide exactly +105V at the D514 cathode and TP501.

Altogether, the parts replaced were 2.7Ω R504; 0.47Ω R525 (that connects to hot ground; one 4A fuse; one 2.5A diode; and one Q503 power-source output transistor.

### Tracking an elusive short

Symptoms of no sound and raster were not unusual for the

RCA CTC111H chassis (Photofact 2038-1). F100, the 5A line fuse, blew after replacement just as quickly as power was applied to the TV receiver. Q404 horizontal-output transistor checked shorted and was replaced. At the next power-up, the fuse did not blow, but there were no picture and raster. Higher-than-normal dc voltage was measured at the SCR100 anode, with near-zero voltages at gate and cathode. When removed from the chassis and tested out-of-circuit, SCR100 was open.

After SCR100 was replaced, the chassis came alive and then went dead. The 4A line fuse was blown and the horizontal-output transistor (Q404) showed excessive collector-to-emitter leakage. Again, the fuse and Q404 were replaced, but the chassis was not powered-up.

A defect in the flyback transformer was suspected. However, replacing the flyback is a difficult job and expensive, so other components of the horizontal-output circuit were tested first. Damper diode CR408 checked leaky and CR409 measured 2Ω resistance across it. Both diodes were removed and tested again. CR408 checked leaky, but CR409 measured the correct forward voltage drop and excellent low leakage. Just to be completely certain, we replaced both CR408 and CR409 and other measurements made. A 2Ω leakage still was across CR409.

One lead of CR409 was unsoldered for tests. CR409 was not shorted, but a 2Ω leakage remained across the circuit where CR409 had been connected. Tracing this near-short to the pincushion-correction circuit brought us to pincushion-driver Q405, which was shorted between emitter and collector (Figure 6).

The components used to this point were 5A fuse, Q404, SCR100, CR408 and CR409. When a new 151329 Q405 was installed, the raster appeared, but with an all-blue picture. The picture tube emissions tested fine, and all dc voltages at the CRT socket were normal except for cathode pin 11, which was very low because spark gap SG1-6 was leaky. Installation of a new spark gap reduced the excessive blue, allowing easy adjust-

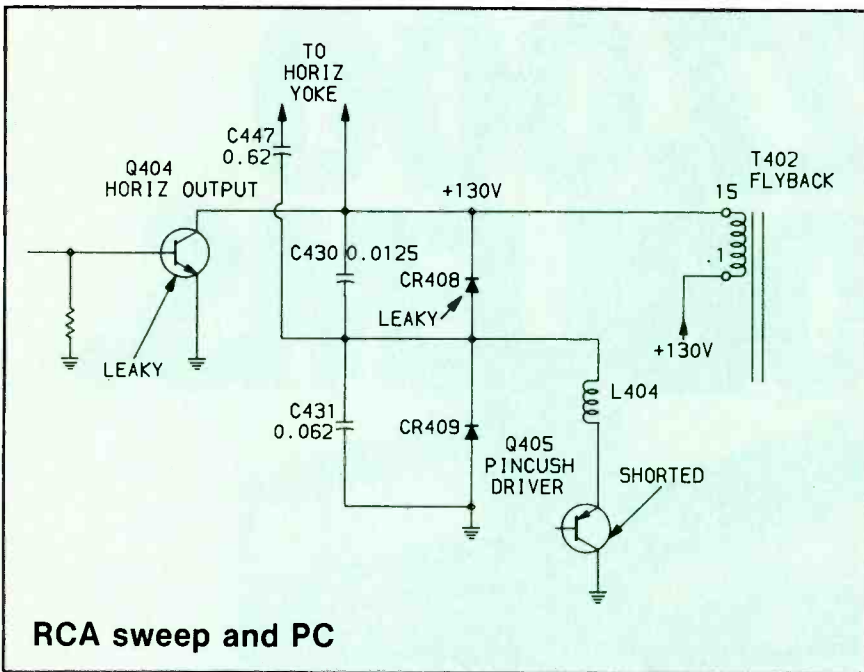


Figure 6. A collector-to-emitter short in Q405 in this RCA pincushion circuit caused failures of Q404 output transistor and CR408, one of the damper diodes.

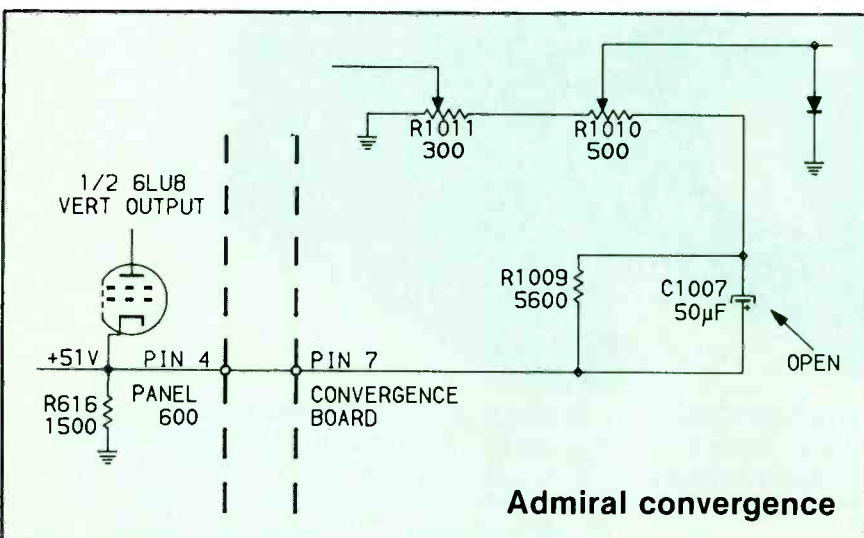


Figure 7. An open 50µF capacitor on the convergence board can cause poor convergence and usually reduce the vertical height excessively. C1007 in this Admiral performs two tasks. One is to bypass the 6L8 cathode (through several low-value resistors on the convergence board), and the other is to supply a waveform from the 6L8 cathode that is needed for proper dynamic convergence. An open capacitor stops both functions.

ment of gray-scale tracking and showing a good color picture. In all, six components plus the spark gap were replaced.

### Loud hum

#### followed by poor convergence

Hum in the speaker and 120Hz hum bars on the raster were the symptoms of an Admiral M2001-2 chassis (Photofact 1328-1). A 100 $\mu$ F test capacitor was paralleled in turn across each of the three C101 sections, and with a noticeable improvement at each. Therefore, we replaced the filter can with a 200 $\mu$ F/160 $\mu$ F/10 $\mu$ F multiple electrolytic capacitor.

Now the hum was gone from sound and picture, but the picture was badly out of convergence. A color-bar/crosshatch generator was connected to the antenna and a complete convergence procedure was performed. However, misconvergence of the green was noticeable near the bottom of the picture. The green lines were curled wrong and could not be straightened. And when the bottom R&G vertical control (R1010) was rotated, nothing happened (Figure 7). After the various controls and the fixed resistors were tested and none found out of tolerance, we noticed an electrolytic capacitor (50 $\mu$ F C1007) that supplies signal from the unbypassed vertical-output-tube cathode to several of these controls. Electrolytics are prone to drying out and becoming open. Therefore, we paralleled another 50 $\mu$ F across C1007 as a test and could see large changes in the convergence. After a new C1007 was installed, it was necessary to reconverge the set again. This time the final convergence was good. As a bonus, the vertical height also was increased, requiring minor adjustments of size and linearity controls.

### Comments

Technicians become accustomed to, but never fond of, several separate defects in the same TV receiver. Multiple defects means *all problems are multiplied*, because some symptoms lead on false trails and others obscure the real culprits. We hope these examples give you ideas about efficient methods of dealing with the double and triple trouble situation.

**ES&T**

# The New Powers of VIZ



## LABORATORY AND INDUSTRIAL DC POWER SUPPLIES

### WP-707A

- \* Dual DC power supply, 0-25V 0-2A
- \* Automatic Short Circuit Shutdown with Reset Button.
- \* Excellent Line & Load Regulation.
- \* LED overload indicators.
- \* Two digital voltmeters with range of 0 to 99.9 VDC. May be used to measure DC source voltage or current.
- \* May be used in series to provide 0-50V DC @ 0-2A



**WP-712A** Single output 20V, 2A with excellent line and load regulation.



**WP-705A** 0-50V, 2A regulated output, DC voltmeter, continuously variable between ranges.

VIZ's line of DC power supplies have a contemporary new design along with up-to-date features and specifications which offer you laboratory and industrial type performance—with style. This line of DC power supplies is well suited for servicing a wide variety of electronic equipment as well as production testing, circuit design, quality inspection and educational applications. Single, Dual & Triple output units are available.

The WP-707A dual power supply has two digital panel meters which can be switched to monitor voltage and, or current of either output.



*The New Power in Test Equipment*

**VIZ TEST EQUIPMENT** division of **VIZ Manufacturing Co.**  
335 E. PRICE STREET, PHILADELPHIA, PA 19144  
215/844-2626 TLX. 710-670-2626 800/523-3696

Circle (14) on Reply Card

# Test your electronic knowledge

Sam Wilson

The questions in this month's quiz are based upon information in articles that appeared recently in *ES&T*.

1. Is this statement correct: An SCR can be tested with fair accuracy using a high-power ohmmeter.  
A.) The statement is correct.  
B.) The statement is not correct.
2. Is this statement correct: For soldering in modern circuits you should use a solder made up of lead, tin and about 3% zinc.  
A.) The statement is correct.  
B.) The statement is not correct.
3. Is this statement correct: Although it was once frowned upon, the shotgun method of locating a faulty component is now recommended for troubleshooting modern electronic systems.  
A.) The statement is correct.  
B.) The statement is not correct.
4. Is this statement correct: If you remove a chip from a circuit board, it can be used again if it is first cleaned thoroughly with alcohol.  
A.) The statement is correct.  
B.) The statement is not correct.
5. Is this statement correct: Individual heads in the upper head cylinder should be replaced periodically as a routine maintenance procedure.  
A.) The statement is correct.  
B.) The statement is not correct.
6. Is this statement correct: The Homodyne receiver is an example of a *single conversion receiver*.  
A.) The statement is correct.  
B.) The statement is not correct.
7. Is this statement correct: A two-way bus can be made with NAND logic gates.  
A.) The statement is correct.  
B.) The statement is not correct.
8. Is this statement correct: An undesirable feature of the matrix scheme for addressing pixels in a graphic display is that a partial turn-on of the pixels reduces contrast.  
A.) The statement is correct.  
B.) The statement is not correct.
9. Is this statement correct: The static charge accompanying a freeze spray may be enough to destroy a MOS IC.  
A.) The statement is correct.  
B.) The statement is not correct.
10. Is this statement correct: The number 330 on a chip resistor means that it is a 330 $\Omega$  resistor.  
A.) The statement is correct.  
B.) The statement is not correct.

- Answers are on page 39

The regular magazine of electronics...  
**ELECTRONIC**  
Servicing & Technology  
February 1986/25

Servicing Video 8's, LV circuits • Video color camera repair, 2  
Splash, splain... flood-damaged electronic equipment

**ELECTRONIC**  
Servicing & Technology  
January 1986/25

The regular magazine of electronics...  
**ELECTRONIC**  
Servicing & Technology  
MARCH 1986/25

Servicing the Commodore 64 • Power protection, electronic equipment  
Efficient troubleshooting: write it down

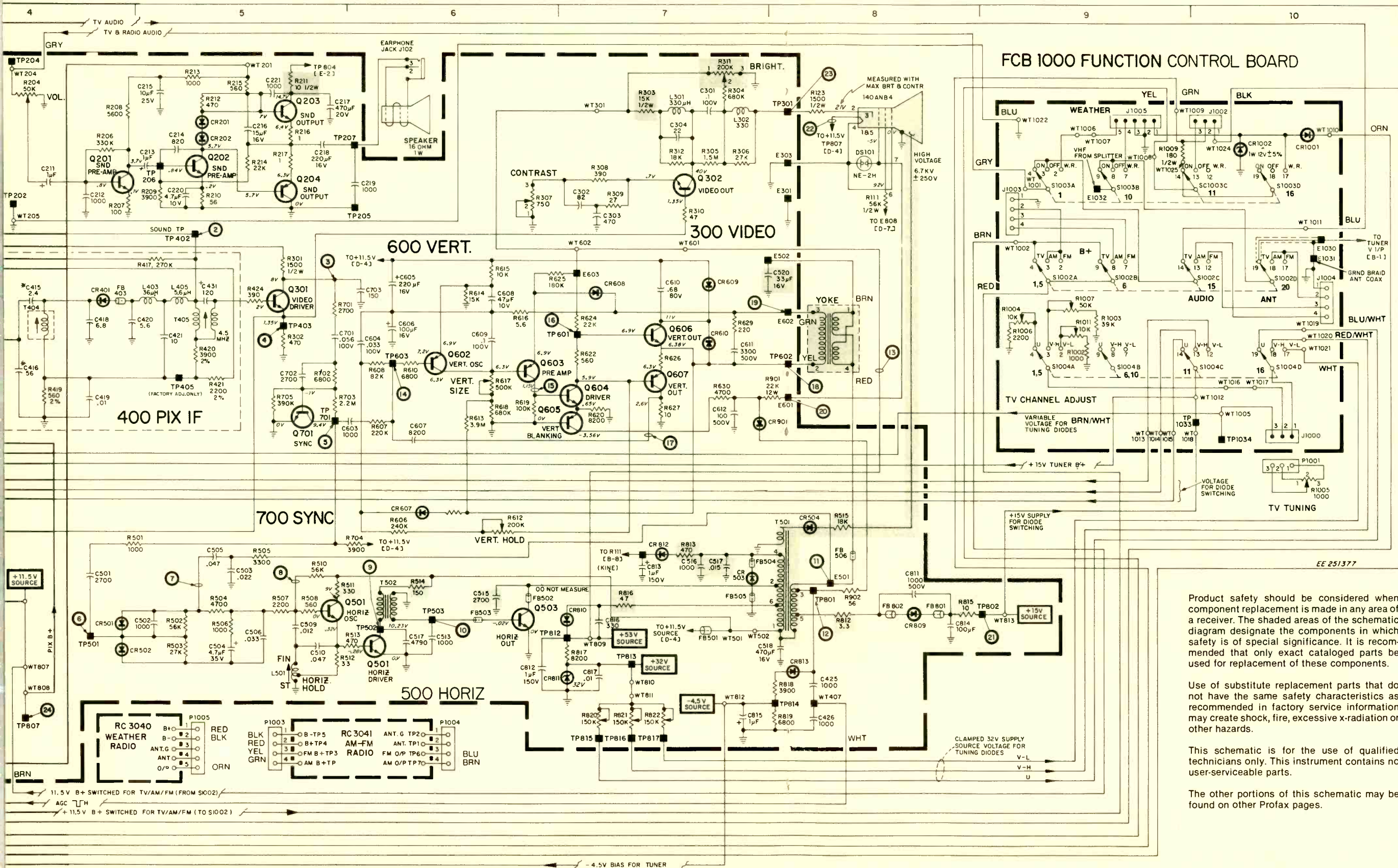
Protecting against  
static electricity  
damage

**ELECTRONIC**  
Servicing & Technology  
SEPTEMBER 1985/25

VCRs—part 2 • The video connection—part 4  
Blowing misconceptions about fuses

Diagnosing  
VCR head  
problems

- NOTES:
- RESISTOR VALUES ARE IN OHMS, K=1000.
  - CAPACITOR VALUES GREATER THAN 1.0 ARE IN PF. THOSE 1.0 AND LESS ARE IN MFD, UNLESS OTHERWISE DESIGNATED.
  - VOLTAGES MEASURED WITH RESPECT TO GND. "VOLTAGE W/ST." WITH SIGNAL CONDITION, AND SHOULD HOLD WITHIN ±20%.
  - ALL RESISTORS ARE 1/4 WATT AND 5% TOLERANCE, EXCEPT WHERE OTHERWISE INDICATED.
    - ⊥ INDICATES GROUND.
    - \* INDICATES 5% TOLERANCE
    - \*\* INDICATES 2% TOLERANCE
    - \*\*\* INDICATES 1% TOLERANCE
    - ( ) RELATES TO ZONING ON PERIMETER OF DRAWING.
    - ( ) VOLTAGES, MEASURED WITH NO SIGNAL.



Product safety should be considered when component replacement is made in any area of a receiver. The shaded areas of the schematic diagram designate the components in which safety is of special significance. It is recommended that only exact cataloged parts be used for replacement of these components.

Use of substitute replacement parts that do not have the same safety characteristics as recommended in factory service information may create shock, fire, excessive x-radiation or other hazards.

This schematic is for the use of qualified technicians only. This instrument contains no user-serviceable parts.

The other portions of this schematic may be found on other Profax pages.

Product safety should be considered when component replacement is made in any area of a receiver. The shaded areas of the schematic diagram designate the components in which safety is of special significance. It is recommended that only exact cataloged parts be used for replacement of these components.

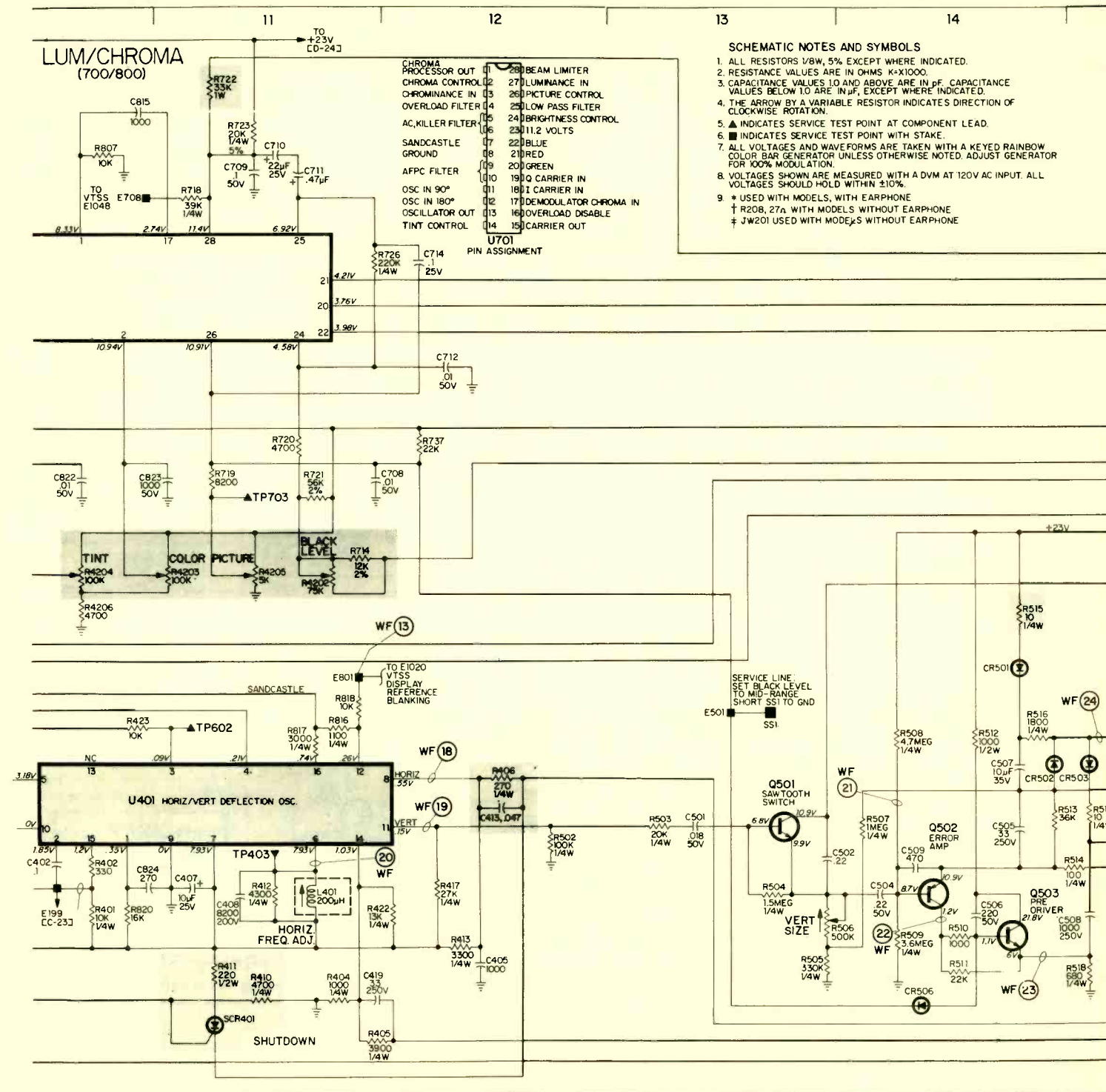
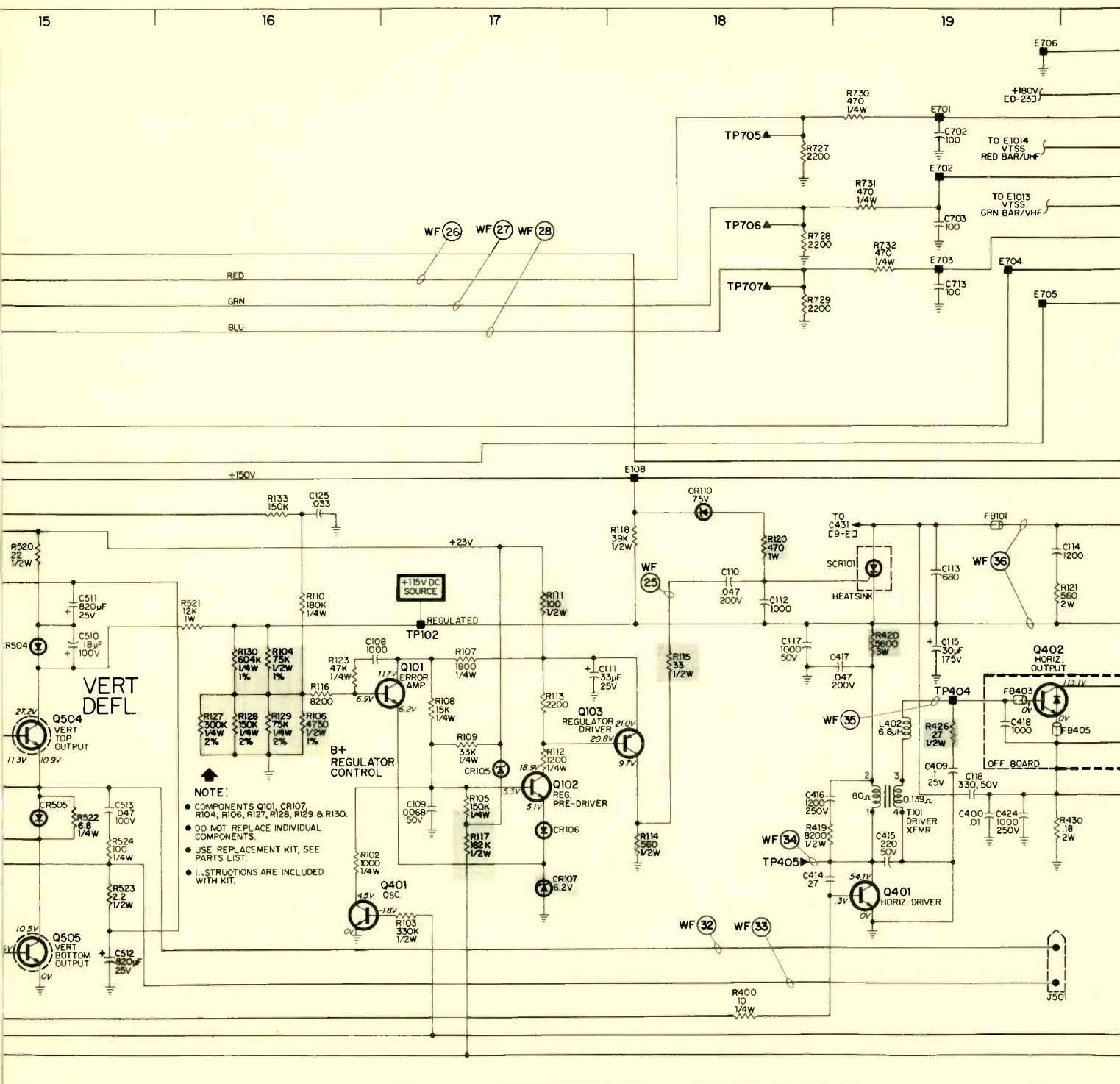
Use of substitute replacement parts that do not have the same safety characteristics as recommended in factory service information may create shock, fire, excessive x-radiation or other hazards.

Product safety should be considered when component replacement is made in any area of a receiver. The shaded areas of the schematic diagram designate the components in which safety is of special significance. It is recommended that only exact cataloged parts be used for replacement of these components.

Use of substitute replacement parts that do not have the same safety characteristics as recommended in factory service information may create shock, fire, excessive x-radiation or other hazards.

This schematic is for the use of qualified technicians only. This instrument contains no user-serviceable parts.

The other portions of this schematic may be found on other Profax pages.



- SCHEMATIC NOTES AND SYMBOLS**
- ALL RESISTORS 1/8W, 5% EXCEPT WHERE INDICATED.
  - RESISTANCE VALUES ARE IN OHMS K-X1000.
  - CAPACITANCE VALUES 1.0 AND ABOVE ARE IN  $\mu$ F. CAPACITANCE VALUES BELOW 1.0 ARE IN nF, EXCEPT WHERE INDICATED.
  - THE ARROW BY A VARIABLE RESISTOR INDICATES DIRECTION OF CLOCKWISE ROTATION.
  - ▲ INDICATES SERVICE TEST POINT AT COMPONENT LEAD.
  - INDICATES SERVICE TEST POINT WITH STAKE.
  - ALL VOLTAGES AND WAVEFORMS ARE TAKEN WITH A KEYED RAINBOW COLOR BAR GENERATOR UNLESS OTHERWISE NOTED. ADJUST GENERATOR FOR 100% MODULATION.
  - VOLTAGES SHOWN ARE MEASURED WITH A DVM AT 120V AC INPUT. ALL VOLTAGES SHOULD HOLD WITHIN  $\pm 10\%$ .
  - \* USED WITH MODELS WITH EARPHONE.  
† R20B, 27 $\Omega$  WITH MODELS WITHOUT EARPHONE.  
‡ JW201 USED WITH MODELS WITHOUT EARPHONE.



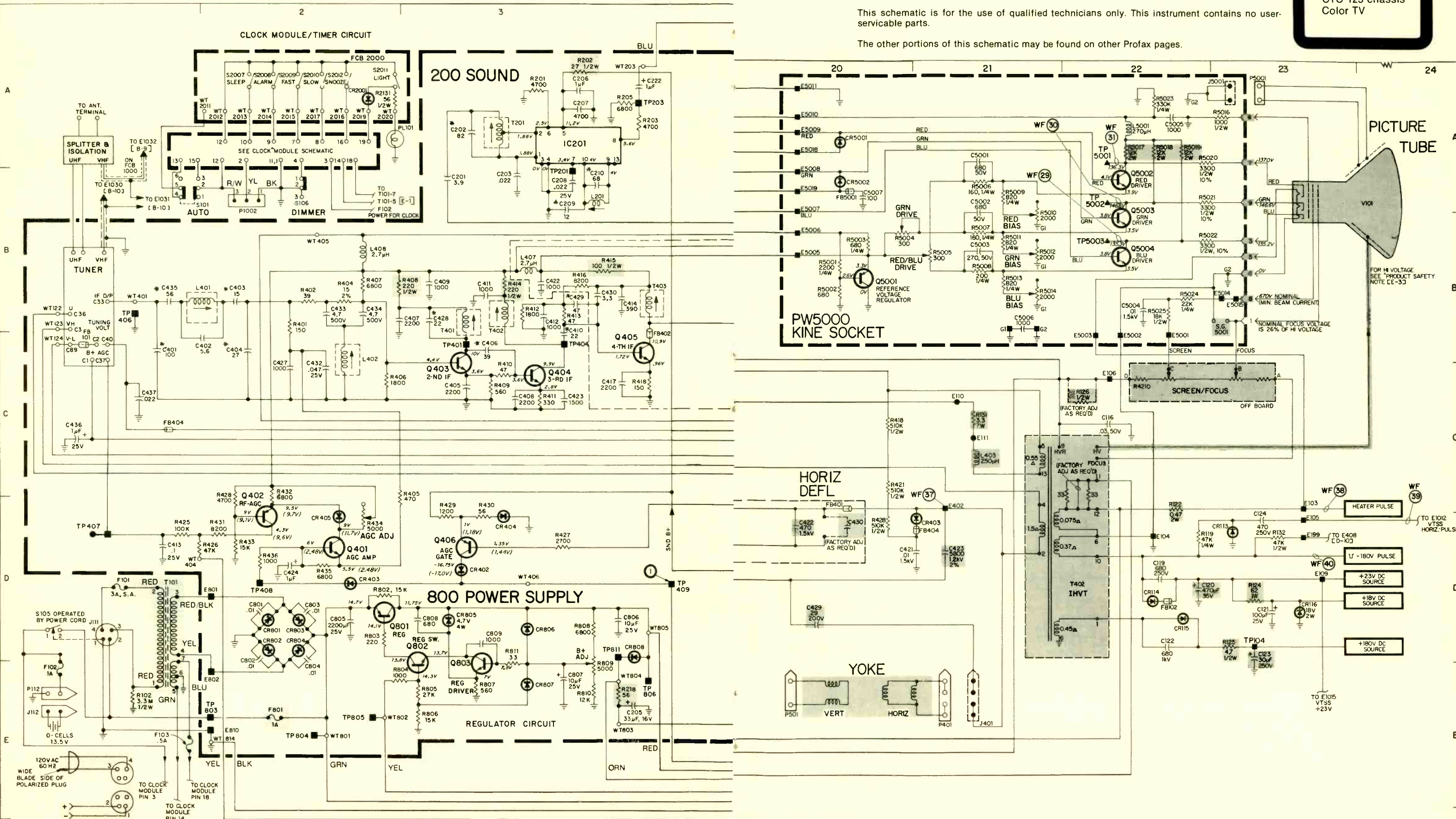
This schematic is for the use of qualified technicians only. This instrument contains no user-serviceable parts.

The other portions of this schematic may be found on other Profax pages.

RCA CTC 125 chassis Color TV

This schematic is for the use of qualified technicians only. This instrument contains no user-serviceable parts.

The other portions of this schematic may be found on other Profax pages.





# Answers to the Quiz

Sam Wilson

Questions are on page 30

1. A Servicing Ward's HV and LV Circuits by Homer L. Davidson. (See Figure 4 for details), 2/86.
2. B Solder: The Tin Tie That Binds by Conrad Persson, 2/86.
3. B Solder: The Tin Tie That Binds by Conrad Persson, 2/86.
4. B Solder: The Tin Tie That Binds by Conrad Persson, 2/86.
5. B An Important Notice—Page 15 of the January '86 issue.
6. A What Do You Know About Electronics? by Sam Wilson, 1/86.
7. A What Do You Know About Electronics? by Sam Wilson, 1/86.
8. A LCD Rivals CRT, page 5, 1/86.
9. A Troubleshooting the Basic Personal Computer System by Bud Izen, 12/85.
10. B What Do You Know About Electronics? by Sam Wilson, 12/85.

**Exclusive, triple patented dynamic cap and coil analyzing . . . guaranteed to pinpoint your problem every time or your money back**



**with the all new LC75 "Z METER 2"  
Capacitor Inductor Analyzer  
Patented \$995**

**The "Z METER" is the only LC tester that enables you to test all capacitors and coils dynamically — plus, it's now faster, more accurate, and checks Equivalent Series Resistance (ESR) plus small wire high resistance coils.**

- **Eliminate expensive part substitution and time-consuming shotgunning** with patented tests that give you results you can trust every time. Test capacitor value, leakage, dielectric absorption, and ESR dynamically; with up to 600 volts applied for guaranteed 100% reliable results — It's exclusive — it's triple patented.
- **Save time and money** with the only 100% reliable, in- or out-of-circuit inductor tester available. Dynamically test inductors for value, shorts, and opens, automatically under "dynamic" circuit conditions.
- **Reduce costly parts inventory** with patented tests you can trust. No more need to stock a large inventory of caps, coils, flybacks, and IHVTs. The "Z METER" eliminates time-consuming and expensive parts substituting with 100% reliable LC analyzing.
- **Turn chaos into cash** by quickly locating transmission line distance to opens and shorts to within feet, in any transmission line.
- **Test troublesome SCRs & TRIACs easily and automatically** without investing in an expensive second tester. The patented "Z METER 2" even tests SCRs, TRIACs, and High-Voltage Diodes dynamically with up to 600 volts applied by adding the new SCR250 SCR and TRIAC Test Accessory for only \$148 or FREE OF CHARGE on Kick Off promotion.

To try the world's only Dynamic LC Tester for yourself, CALL TODAY, WATS FREE, 1-800-843-3338, for a FREE 15 day Self Demo.



**SENCORE**

3200 Sencore Drive  
Sioux Falls, SD 57107  
605-339-0100 In SD Only  
innovatively designed with your time in mind

**CALL TODAY  
WATS FREE  
1-800-843-3338**

Circle (15) on Reply Card

# Replacement parts

Sometimes when you've diagnosed an equipment failure down to the component level, your problems have just begun. Here are hints and tips on identifying and procuring the correct replacement component.

By Conrad Persson

In most how-to servicing articles, including most of the servicing articles in *ES&T*, troubleshooting, diagnosis and circuit theory are emphasized and identification, procurement and handling of replacement parts are treated as trivial pursuits.

Unfortunately, these processes are frequently not as trivial as they seem, and, in fact, on occasion, identifying the malfunctioning component and finding a source of supply for the replacement becomes the hardest part of the entire repair process. This article gives you some hints on identifying components that are not readily identifiable, gives you a list of names and addresses of suppliers and suggests ways of handling the replacement devices so that you don't damage them before the repair is completed.

## General replacement notes

Here are a few general suggestions from the repair parts suppliers on selecting replacement parts when the exact replacement is not available and a substitute part may be used.

Use replacement parts with;

- equal or greater breakdown voltage.
- equal or greater operating current.
- equal or greater power dissipation.
- equal or greater gain bandwidth product.
- equal or lower switching time.
- equal or lower trigger current.
- equal or lower reverse current.

## Lead arrangement

Before replacing a failed component, compare its lead arrangement with that of the replacement device. If it is not the same, bend the leads of the replacement device so that the leads will connect to the correct terminals. If this bending results in the possibility of shorting leads together, use some kind of insulating material to eliminate this possibility.

## Push-pull power amplifiers

When one transistor in a push-

pull power amplifier stage fails, the circuit becomes unbalanced. This unbalance is very likely to produce changes in the operating conditions of that stage, possibly large changes. Depending on the cause of failure of the transistor, other components in the stage may have been damaged.

Parts suppliers recommend that you replace both or all transistors in a push-pull stage. It is generally considered advisable to replace transistors in a push-pull stage with matched components even if the service literature doesn't specifically call for a matched pair.

## Rectifiers

When you replace a rectifier, it is possible to replace a selenium or other metallic-oxide device with a silicon rectifier. However, the silicon rectifier will be more efficient, delivering 25V to 50V higher dc output voltage than the original component in the B supply of a typical line-operated radio or television.

To prevent damage caused by this higher-than-design value of voltage, it is a good idea to place a power resistor in series with the silicon rectifier either between the ac supply and the rectifiers, or between the rectifier and the first capacitor.

This article was based on information tips and hints found in parts catalogs of Philips ECG, General Electric, MCM, Motorola, New Tone Electronics, RCA-SK, Workman Electronics and Zenith.

# Analyze defective waveforms faster, more accurately, and more confidently — every time ... or your money back

## Triplers and horizontal-output transistors

When replacing an original equipment high-voltage tripler, compare the arrangement of the leads of the two devices, carefully noting the lead positions with respect to other circuit components. Make every effort to be sure that the replacement unit comes as close to this configuration as possible.

When a horizontal output transistor fails, other components may have initiated the failure, or may have been damaged by the failure. Before replacing one of these units, carefully check all associated circuit components such as the horizontal oscillator, the flyback transformer, high-voltage multipliers, and any resistors and capacitors. If any of these is faulty and is not replaced at the same time as the horizontal-output transistor, it could cause destruction of the replacement.

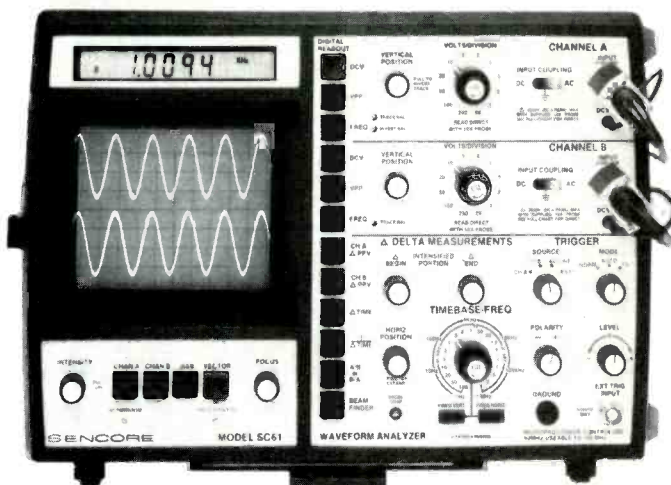
## Repeated failures

If you find that one semiconductor fails repeatedly, it could be that it was of marginal design for the application it's in. It may be operating too close to, or even above, its designed voltage, current or ambient operating temperature. A simple fix in a situation such as this is to replace the problem device with one that has a higher voltage or current specification. Or, in the case of excessive heat, you might increase the size of the heat sink or install a heat sink where there is none.

## Handling replacement parts

Placing a replacement device in a circuit frequently requires bending of the leads. If this is not done carefully, the point where the lead enters the device may be stressed, which can lead to cracking the material (glass, plastic, etc.) of which the device is constructed.

To avoid problems such as this, use a tool such as long-nosed pliers. Grasp the lead in the pliers and bend the lead against the pliers instead of the body of the component. This will avoid stress-related problems.



with the SC61 Waveform Analyzer  
Patented \$2,995

**If you value your precious time, you will really want to check out what the exclusively patented SC61 Waveform Analyzer can do for you. 10 times faster, 10 times more accurate, with zero chance of error.**

- **End frustrating fiddling with confusing controls.** Exclusive ultra solid ECL balanced noise cancelling sync amplifiers, simplified controls, and bright blue dual trace CRT helps you measure signals to 100 MHz easier than ever.
- **Accurately and confidently measure waveforms from a tiny 5 mV all the way to a whopping 3,000 V without hesitation** with patented 3,000 VPP input protection — eliminates expensive "front end" repairs and costly equipment downtime.
- **Make only one circuit connection and push one button for each circuit parameter test:** You can instantly read out DC volts, peak-to-peak volts and frequency 100% automatically with digital speed and accuracy. It's a real troubleshooting confidence builder.
- **Confidently analyze complex waveforms fast and easily.** Exclusive Delta measurements let you intensify any waveform portion. Analyze glitches, interference signals, rise or fall times or voltage equivalents between levels; direct in frequency or microseconds.
- **Speed your digital logic circuit testing.** Analyzing troublesome divide and multiply stages is quicker and error free — no time-consuming graticule counting or calculations. Simply connect one test lead to any test point, push a button, for test of your choice, for **ERROR FREE** results.

To see what the SC61 can do for your troubleshooting personal productivity and analyzing confidence, **CALL TODAY, WATS FREE, 1-800-843-3338**, for a **FREE 15 day Self Demo.**



**SENCORE**

3200 Sencore Drive  
Sioux Falls, SD 57107  
605-339-0100 In SD Only  
innovatively designed with your time in mind

**CALL TODAY  
WATS FREE  
1-800-843-3338**

# Parts suppliers

Some of these suppliers sell through traditional distributors, some sell via mail order. Check them out. You might be surprised to find that suppliers like Phillips ECG, RCA-SK, New Tone, Zenith and others, who you thought sold only TV parts, can provide you with replacement digital ICs for computers, remote control units, test meters and more.

**Abatron Electronics**  
971 Ball Ave.  
Union, NJ 07083

**All Electronics Corp.**  
905 South Vermont Ave.  
Los Angeles, CA 90006

**Allied Electronics**  
401 E. Eighth St.  
Fort Worth, TX 76102

**Alpha Electronics Inc.**  
1365 39th St.  
Brooklyn, NY 11218

**Antique Electronic Supply**  
1725 W. University  
Tempe, AZ 85281

**Asti Magnetics**  
32 Piermont Road  
Cresskill, NJ 07626

**Circuit Specialists**  
Box 3047  
Scottsdale, AZ 85257

**Consolidated Electronics**  
705 Watervliet Ave.  
Dayton, OH 45420-2599

**Dalbani Corp. of America**  
785 E. 14th St.  
Los Angeles, CA 90021

**Dick Smith Electronics**  
P.O. Box 2249  
Redwood City, CA 99063

**Digi-Key**  
P.O. Box 677  
Thief River Falls, MN 56701

**Digitron Electronics**  
110 Hillside Ave.  
Springfield, NJ 07081

**E.S.I. Inc.**  
3171 Hempstead Turnpike  
Levittown, NY 11756

**Electronic Salvage Parts**  
2706 Middle Country Road  
Centereach, NY 11720

**Electronic Parts Supply**  
741 E. 14th St.  
Oakland, CA 94606

**Electronics Warehouse Corp.**  
1910 Coney Island Ave.  
Brooklyn, NY 11230

**Etco Electronics**  
North Country Shop Center  
Plattsburg, NY 12901

**EVG Inc.**  
1 Lee Place  
Freeport, NY 11520

**Fox International**  
23600 Aurora Road  
Bedford Heights, OH 44146

**Fuji-SVEA**  
P.O. Box 3375  
Torrance, CA 90510

**GC Electronics**  
400 South Wyman St.  
Rockford, IL 61101

**Jameco Electronics**  
1355 Shoreway Road  
Belmont, CA 94002

**Matsushita Engineering & Service**  
50 Meadowlands Parkway  
Secaucus, NJ 07094

**MCM Electronics**  
858 E. Congress Park Drive  
Centerville, OH 45459-4072

**Mid America Company**  
2309 South Archer  
Chicago, IL 60616

**Milo Associates**  
4169 Millersville Road  
Indianapolis, IN 46205

**Mouser Electronics**  
P.O. Box 9003  
Lakeside, CA 92040

**New-Tone Electronics**  
44 Farrand St.  
Bloomfield, NJ 07003

**Nippon America Inc.**  
9600 NW 12th St.  
Miami, FL 33172

**OHM/Electronics**  
746 Vermont Ave.  
Palatine, IL 60067

**Omnitron Electronics**  
770 Amsterdam Ave.  
New York, NY 10025

**Optima Electronics**  
2022 Tigertail Blvd.  
Dania, FL 33004

**Pan Son Electronics**  
32-70 31st St.  
Long Island City, NY 11106

**Pfanstiehl Chemical Corp.**  
3300 Washington St.  
Waukegan, IL 60085

**Philips ECG**  
100 First Ave.  
Waltham, MA 02254

**Projector Recorder Belt**  
200 Clay St.  
Whitewater, WI 53190-0176

**RCA Distributor and Special  
Products**  
2000 Clements Bridge Road  
Deptford, NJ 08096

**Richardson Electronics, Ltd.**  
3030 N. River Road  
Franklin Park, IL 60131

**TEC**  
83 East Central Ave.  
Pearl River, NY 10965

**Thordarson-Meissner**  
628 Belmont St.  
Mt. Carmel, IL 62863

**Unity Electronics**  
P.O. Box 213  
Elizabeth, NJ 07206

**Workman Electronics Products**  
75 Packinghouse Road  
Sarasota, FL 33578

**Zenith Service, Parts  
and Accessories**  
11000 Seymour Ave  
Franklin Park, IL 60131

**Now test and restore every CRT on the  
market . . . without ever buying another  
adaptor socket or coming up  
embarrassingly short in front of your  
customer . . . or your money back**



**with the new improved CR70 "BEAM BUILDER"  
Universal CRT Tester and Restorer  
Patented \$995**

**Have you ever?**

- **Thrown away a good TV CRT, data display CRT, or scope CRT** that could have been used for another two or three years because you had no way to test or restore it?
- **Lost valuable customers** because you advised them that they needed a new CRT when another technician came along and restored the CRT for them?
- **Lost the profitable extra \$35 or more** that you could have gotten for restoring a CRT while on the job and locked in the profitable CRT sale later?
- **Avoided handling profitable trade-ins or rentals** because you were afraid you'd have to replace the picture tube when you could have restored it?
- **Had a real need to test a CRT on the job, but didn't have the right adaptor socket or setup information** in your setup book?

**If any of these things have happened to you, CALL TODAY, WATS FREE, 1-800-843-3338, for a FREE 15 day Self Demo.**



**SENCORE**

3200 Sencore Drive  
Sioux Falls, SD 57107  
605-339-0100 In SD Only  
innovatively designed with your time in mind

**CALL TODAY  
WATS FREE  
1-800-843-3338**

Circle (17) on Reply Card

MOS devices are susceptible to damage caused by electrostatic discharge. Accordingly, precautions should be taken to ensure that static electricity in the vicinity of the work area where MOS device replacements will be handled is discharged before the device is taken out of its package, and that any static electricity buildup that takes place while handling the MOS device is drained away as it occurs.

The following precautions are recommended to prevent electrostatic discharge damage:

- When you're handling MOS devices, wear a wrist strap that's connected to ground through a  $1\text{m}\Omega$  resistor.
- Use only soldering irons that have grounded tips.
- Never remove or insert a device with the power *on*.
- Always leave the device in its conductive foam until you are ready to insert it into the circuit.

### Soldering

Careless use of the soldering iron or using the wrong soldering iron can lead to damage to the device or lifting of circuit traces. Always use the wattage of soldering iron recommended by the service literature, and use it carefully.

- Solder as far away as possible from the body of a semiconductor.
- Always use a soldering heat sink, or grasp the lead being soldered in a pair of pliers to conduct the heat away from the body of the component.
- Keep the surfaces to be soldered clean, and the tip of the iron well tinned so that the solder joint can be completed quickly.
- Never apply the soldering tool or molten solder to the lead for more than 10 seconds. And never apply the soldering iron to the lead closer than 1/16 of an inch to the body of the device.
- Use the kind of solder recommended by the manufacturer of the product. If there is no specific recommendation, use a good quality of 60/40 (60% tin, 40% lead) solder to make sure that you make the joints quickly with a minimum of heat.
- If the soldering iron is leaking electrically between the heating

element and the tip, the tip may be above ground potential. This leakage voltage may cause damage to replacement semiconductor devices if the chassis has a return to ground. To be on the safe side, you should either use a soldering iron that is equipped with a ground, or when you're soldering solid-state devices (especially static-sensitive MOS devices), connect a flexible grounding strap from the metal neck of the soldering iron to ground.

One of the nightmares when you're servicing an electronic product is to run across a failed semiconductor device that's not marked and you don't have the manufacturer's literature to help you find out what the device is. What next?

The Philips "ECG Semiconductor Master Replacement Guide" suggests 10 steps to selecting a correct replacement semiconductor, even if you can't identify the defective unit exactly:

- First determine if the device is PNP or NPN. If you can determine which of the device leads is for the base, emitter and collector, you can then measure the circuit voltages at those leads. If the collector voltage is positive with respect to the emitter voltage you know that it is NPN. Conversely, if the voltage at the emitter is positive with respect to the voltage at the collector, it is a PNP device.
- The second step is to determine if the device is silicon or germanium. If you have a copy of the schematic diagram, check the bias conditions. If the dc bias voltage between base and emitter is 0.4V or more, the device is most likely a silicon transistor. If this voltage is 0.2 or less, the device is most likely germanium.
- In some circuits, there will be no bias voltage present. In such a case, the relative complexity of the ancillary circuitry will provide a clue. Germanium devices are more susceptible to changes of temperature, and have higher leakage currents than do silicon devices, and so ordinarily will have several devices in circuit to compensate for these characteristics. For example, the bias voltage is compensated with the use of voltage

dividers, and an emitter-limiting resistor always is used.

- Another important characteristic of the component is the range of frequencies it will operate under. You can identify the required operating frequency by determining the type of circuit the component is in. Does the circuit in question operate in the audio range, the kilohertz range or the megahertz range?

- To determine the required collector-to-emitter breakdown, have a look at the voltage values called out on the schematic. It's usually wise to select a replacement device with  $BV_{CEO}$  somewhat greater than the supply voltage. The higher the value of  $BV_{CEO}$ , the better.

- Once you have found the collector-to-emitter maximum voltage, you can use this figure also for  $BV_{CEO}$ .

- To determine the required collector current value, have a look at the circuit schematic values, and assume the transistor is fully *on*. What value of current will flow under those conditions? I Max. should be greater than this figure.

- The maximum current and voltage figures will give you the maximum power that will have to be dissipated by the device. The type of circuit in which the device will be used is the primary determinant of power dissipation. Here are some rough figures:

Input stages—50mW to 200mW  
IF and driver stages—200mW to one watt.

Higher power output stages—greater than a watt

- The gain of the device to be used as a replacement depends largely on the type of circuit it will be used in. Here are some typical circuit types and the gains required:

RF, mixers, IF, AF—80 to 150  
RF and AF drivers—25 to 80  
RF and AF output—4 to 40

High-gain pre-amps and sync separators—150 to 500

- Once you have determined all the electrical characteristics that the replacement device must have, you may consider the physical requirements. If the information available does not indicate that an exact replacement is required, most likely any device with the



correct electrical characteristics that will fit into the circuit will operate acceptably.

• Try to find a replacement unit with lead configuration similar to the original unit. Unless appearance is critical, though, this factor probably is not terribly important, as long as you can bend the leads of the replacement to fit.

When video games and personal computers were added to the list of electronic products bought by consumers, besides enhancing leisure hours at home and helping people do their personal accounting, word processing and other tasks, they also became a servicing opportunity for individuals who wanted to repair their own or other people's digital products.

**Today many replacement parts for video games and personal computers are available from sources of supply long familiar to servicing technicians, through well known distributors.**

A replacement parts problem came along with the servicing opportunity. In the first place, many of the parts were unfamiliar: products like ROMs, RAM, I/O chips and microcomputer chips. Not only were the parts unfamiliar, but where do you go to get replacement parts when components and ICs fail in a personal computer?

For a while this was a real problem, but that situation didn't last very long. Traditional suppliers of parts for television, video, audio and other consumer electronic products were quick to recognize the opportunity, and today many replacement parts for video games and personal computers are available from sources of supply long familiar to servicing technicians through well known distributors. In some cases where components may not be available through these channels, there are mail-order suppliers who can supply the replacements.

The listing that accompanies this article will help you identify sources of the replacement parts you need.

**ES&T**

## Walk "tough dog" troubles out of any TV & VCR in half the time . . . or your money back



with the exclusive, patented,  
VA62 Universal Video Analyzer . . . \$3,295

Would you like to?

- **Reduce analyzing time:** Isolate any problem to one stage in any TV or VCR in minutes, without breaking a circuit connection, using the tried and proven signal substitution method of troubleshooting?
- **Cut costly callbacks and increase customer referrals** by completely performance testing TVs & VCRs before they leave your shop? Own the only analyzer that equips you to check all standard and cable channels with digital accuracy? Check complete, RF, IF, video and chroma response of any chassis in minutes without taking the back off the receiver or removing chassis plus set traps dynamically right on CRT too? Simplify alignment with exclusive multiburst pattern.
- **Reduce costly inventory from stocking yokes, flybacks, and other coils and transformers, for substitution only,** with the patented Ringing Test. Run dynamic proof positive test on any yoke, flyback, and integrated high voltage transformer . . . in-, or out-of-circuit?
- **Protect your future** by servicing VCRs for your customers before they go to your competition? Walk out "tough dog" troubles in any VCR chrominance or luminance circuit — stage by stage — to isolate problems in minutes? Have a proof positive test of the video record/play heads before you replace the entire mechanism?
- **Increase your business** by meeting all TV and VCR manufacturers' requirements for profitable warranty service work with this one universally recommended analyzer.

To prove it to yourself, CALL TODAY, WATS FREE, 1-800-843-3338, for a FREE Self Demo . . . or learn how the VA62 works first by calling for your free simplified operation and application instruction guide, worth \$10.00.



**SENCORE**

3200 Sencore Drive  
Sioux Falls, SD 57107  
605-339-0100 In SD Only

innovatively designed with your time in mind

**CALL TODAY  
WATS FREE  
1-800-843-3338**

Circle (18) on Reply Card

# Buying and fixing *as-is* electronics products

By Victor Meeldijk



**Figure 1.** A wide variety of bargains may be found on the electronics retailer's bargain table.

The variety of merchandise on the bargain table is endless. Multimeters, clock radios, calculators, electronic equipment and even television sets can be found. (See Figure 1.) The first step in selecting an item to purchase is the visual inspection. Note any cosmetic defects, missing knobs, covers and especially hardware. Missing hardware may be an indication that someone unsuccessfully tried to repair the unit. Try to examine the insides of the unit, either by removing the back (if it has a snap-on cover) or by looking through a ventilation slot. Any components that have been solder tacked in place, or are missing, will confirm past troubleshooting attempts. This becomes a questionable item, and only an extremely low price should entice you to buy it.



**Figure 2.** This calculator switch was assembled with the contact in the wrong slot.

During the visual examination, be aware that any missing cabinet parts such as knobs or covers may be difficult to replace. All knobs will have to be replaced if one of a matched set is missing. Covers may have to be fabricated to match the cabinet of the device. More details on this will be covered in the paragraph on cosmetic repairs.

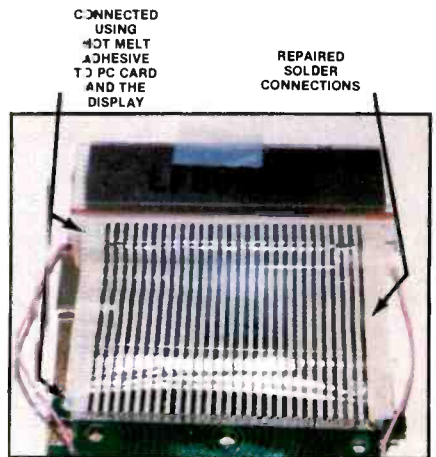
Next, look at the brand name and model number. If it is a new or recent model by a well known manufacturer, schematics, test data and repair parts will be easily obtainable. Many consumer items are brand named for the particular store in which they are sold. Often the same items can be found under a few different labels, and information about the product may be obtained from a source other than the one on the nameplate. An example of this is that some of the calculators sold under the Radio Shack label actually are manufactured by Texas Instruments. Radio Shack does provide excellent repair information and parts for the items they sell. Similar items also may have almost identical schematic diagrams. A schematic



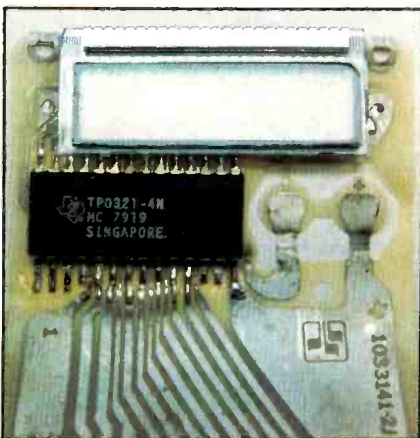
**Figure 3.** Don't buy an item with a cracked/blackened LCD display.

you already have may be useful in repairing a bargain purchase. An example of this will be discussed in the paragraph on TV purchases.

After visual checks, an operational check is made observing all malfunction symptoms. The store usually will allow this evaluation, which also aids price negotiations, particularly if the unit doesn't function. Knowing the malfunction symptoms, examine the unit looking for blown fuses, loose wires or poor solder connections. The latter, along with manufacturing errors, is the basic cause for customer-returned merchandise. (See Figure 2.)



**Figure 4.** The connectors in this solar calculator consisted of carbon traces deposited on a plastic film. Broken traces were repaired by going over them with a soft pencil.



**Figure 5.** Reheating the solder joints around the IC in this scientific calculator restored it to operation.



**Figure 6.** The portable AM radio in which this poor solder connection was found was completely dead until I tapped the printed-circuit board. Under magnification this connection was obviously bad. Reheating it brought the radio to life.



**Figure 7.** In this electronic clock, diagnosis showed that a pull-down resistor *inside* the IC was open. Adding a 14.2k $\Omega$  resistor to the circuit *outside* the IC case restored proper operation.



**Figure 8.** The control spring in this meter had broken, resulting in absence of movement. In such a case, a fine-tipped soldering iron, or one that has been modified as shown here, may be used to solder it back into place.

Malfunctioning items such as calculators, electronic clocks and watches often are built around one main component: an LSI (large scale integrated) microcircuit. These microcircuits can be impossible to replace, or they sell for a price close to the cost of a new clock or calculator. Specific selection and repair techniques for these and other items are covered in the following paragraphs.

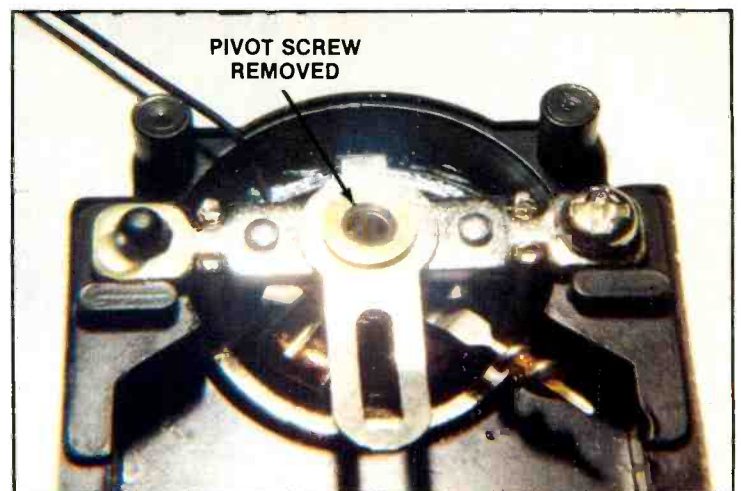
### Calculators

One of the most prevalent items found on the bargain table is the pocket calculator. Many styles and models ranging from the basic

4-function, to solar-powered, to scientific calculators often are available. As already recommended, the first thing to do is to examine any potential purchase visually for signs of abuse or previous repair work. Any LCD (liquid crystal display) unit that has a cracked or blackened display should be discarded immediately. (See Figure 3.) If several units are available that are all non-functioning, it can be assumed that a manufacturing defect or assembly error may be the problem.

Poor connections or cold solder joints may be verified by observing the calculator operation. If there is no display or if segments are missing, gently apply pressure to the calculator case, especially around the display. Be extremely careful with liquid crystal displays, as they are made of glass and fracture easily. If the display changes or the calculator suddenly operates normally, poor internal connections are the problem and repairs should be relatively easy and accomplished at low cost.

Figures 4 and 5 show scientific



**Figure 9.** This battery-tester meter movement was repaired by removing the pivot screw, centering the pivot point through the screw hole and replacing the screw.

and solar-powered calculators that required only internal connection rework. For the scientific calculator, solder joints were reheated around the integrated circuit. (Note that to do this type of repair, a grounded soldering iron should be used to prevent the integrated circuit from being damaged by static electricity.) The solar-powered unit required a more complex repair.

As seen in the photograph, part of the electrical circuit is made by carbon traces deposited on a thin plastic film. This film then was bonded to the printed circuit card and the display. A multimeter confirmed that some traces were open-circuited, while a visual examination showed that other connections had separated from either the printed circuit card or the display. Using a pencil, the open carbon traces were repaired by depositing a layer of graphite where the connections were broken.

Reattaching the plastic film conductor could have been accomplished with an electrically conductive adhesive. However, as this was not immediately available, I used a different method. I aligned the film conductor with both the PC card and the display, then placed thin strips of adhesive-backed rubber on the back of the conductor where there were connection problems. The back cover of the calculator case pressed on the rubber strips forcing the conductive film to make electrical contact with the PC card and the display.

### Radios/clock radios

This is another group of items commonly found on the bargain table. In the case of clock radios, determine whether it is the clock or the radio that's malfunctioning.

In radio repairs, use the basic troubleshooting techniques of signal tracing and injection. Be alert for failed electrolytic capacitors, especially in older units, and suspect plastic- or epoxy-encapsulated transistors when there are audio output problems. One interesting problem I observed was a radio with a

microphonic output: Tapping the radio case resulted in an audio output. I traced this problem to the ceramic disc capacitor that coupled the audio amplifier to the volume control potentiometer.

Solder connection problems are also common. A portable AM radio, purchased for \$2, was dead until the circuit card was tapped, or flexed, near the station adjust-

ment knob. Although the poor connection that caused this may not look any different than any other one, examination under magnification shows a gap around the component lead and the solder pad. (See Figure 6.)

Clocks either may be electromechanical or electronic. The electromechanical versions are replaced easily at low cost as long

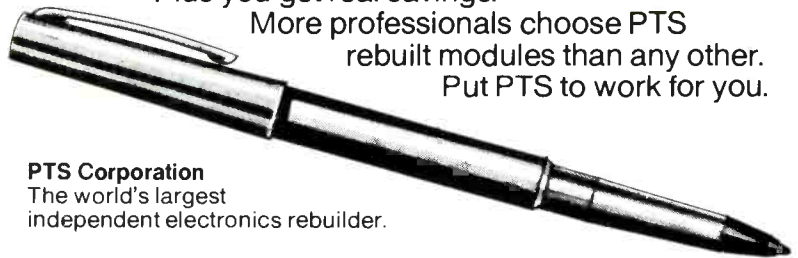
# PTS SLASHES MODULE PRICES UP TO 50%!

Your new PTS Product Guide has great news. PTS is cutting prices on popular modules by 10 to 50%!

Choose quality PTS replacement parts. You get automatic up-dates, full 90-day limited warranty, and in-stock availability or fast 8-hour turnaround of all makes/all models.

Plus you get real savings.

More professionals choose PTS rebuilt modules than any other. Put PTS to work for you.



**PTS Corporation**  
The world's largest independent electronics rebuilder.

Send for your free Product Guide today!

RCA		REPAIR PRICE		RCA		REPAIR PRICE		
MODULE #	REPAIR PRICE	MODULE #	REPAIR PRICE	MODULE #	REPAIR PRICE	MODULE #	REPAIR PRICE	
MAG001B	19.48	13.15	MCH001B	26.20	17.05	MAE001B	19.20	12.85
MAH001B	21.70	14.35	MDS001A	20.25	15.05	MCS001A	21.30	14.50
MDR001A	16.80	12.95	MDS001B	20.25	10.00	MDS001B	21.10	12.00
MDG001A	21.30	15.35	MAC002B	21.10	16.30	MDL002A	23.70	18.35
MAH004C	24.05	17.40	MCL002A	25.55	23.95	MAG004A W	28.30	8.30
MCH002B	26.20	17.05	MAA001A	11.25	30.50	MAA001A	11.25	8.30
MDD001A	16.80	12.20	MAST007RA	61.80				
MDC001A	24.70	17.85						
MAD001	15.65	11.00						
	16.45	9.10						

Circle (19) on Reply Card

If the (clock) motor does not rotate when energized but an ohmmeter check of the armature shows continuity, the motor may need only to be lubricated.

as the proper spacing between control shafts is observed when purchasing a replacement. Before replacement, however, determine if the problem is caused by a stuck clock motor. If the motor does not rotate when energized but an ohmmeter check of the armature shows continuity, the motor may need only to be lubricated.

Remove the motor and heat it with a heat gun or soldering iron. Drop some light lubricating oil around the motor shaft and allow the motor to cool. Add more oil as it cools. Heating and cooling the assembly results in a vacuum that sucks the oil into the motor. Gently rotate the shaft with a pair of long-nose pliers, taking care not to damage any gears attached to the shaft. If the problem was simply one of a frozen mechanism, the motor now should operate properly and can be installed into the clock movement.

Electronic clocks, like calculators, often contain a single integrated circuit as the main circuitry. Unless a replacement IC can be obtained, which may prove difficult, assemblies with malfunctioning electronic clocks should be avoided, unless the cost is low and you wish to experiment.

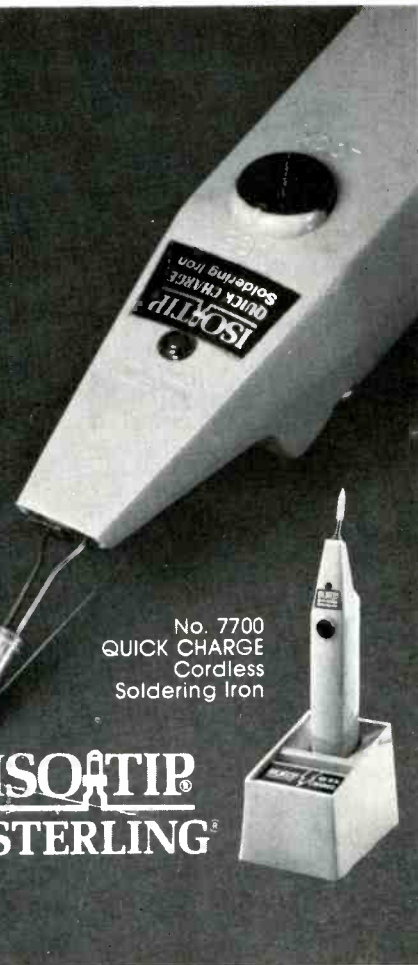
I performed one such experiment on a clock that was stuck in the calendar mode. Obtaining a data sheet from the manufacturer of the clock IC, Electronic Arrays P/N EA7317B, I discovered that an internal pull-down resistor connected to pin 24 enabled the clock mode unless 20V was applied to the pin. In this case, pin 24 was at 20V. Installing a 14.2KΩ resistor between this pin and ground (pin 29) pulled the voltage down to 14.5V restoring proper clock/calendar operation. This is obviously a special case but it did allow for experimentation and the use of an

Quick charge cordless soldering iron. Up to 125 electronics joints per charge. Total recharge in less than 4 hours. Isolated tip design. One of more than 2 dozen ISO-TIP and STERLING irons available. Write for free catalog and name of nearest distributor.

## A Hot Tip on Cordless Soldering

**ISO-TIP®**  
**STERLING®**

WAHL CLIPPER CORPORATION  
Sterling, Illinois 61081 • (815) 625-6525



No. 7700  
QUICK CHARGE  
Cordless  
Soldering Iron

Circle (20) on Reply Card

## PRB . . . OFFERS THE PROFITABLE SYSTEM FOR SELLING VIDEO RECORDER BELTS



The PRB stock number describes the required belt. You just size the belt on our handy MEASURE-A-BELT gauge and you'll have all the info needed to find your belt. The PRB System is fast, easy and profitable!  
For details on our profitable belt system and the complete line of PRB electronic components just call toll free . . .

National 1-800-558-9572	In Wisconsin 1-800-242-9553
Business Number 1-414-473-2151	TLX 4994411 PRB USA
In Canada call collect: 1-613-225-5003	

**PRB**  
PROJECTOR RECORDER BELT  
200 Clay Street, Whitewater, WI 53190

Circle (21) on Reply Card

unusual repair technique. (See Figure 7.)

### Meters/multimeters

Analog panel meters and multimeters often are reduced in price because of broken meter faces or inoperability. It may be possible to repair the meter movement by the following method:

Verify that the movement is the problem by connecting a series circuit consisting of a variable resistor (set to 10kΩ) and a 1.5V battery to the meter. Slowly reduce the resistance, watching for meter deflection. If the meter pins to the left, reverse the battery connections.

If the meter oscillates, examine the control springs (Figure 8). One spring is probably touching the meter chassis as the moving coil is rotating. Insulate the chassis either with some tape or glyptol.

If no movement is observed,

carefully examine the meter with a magnifying glass. Look at the control springs and verify that they still are making electrical contact from the meter leads to the moving coil assembly. The control spring often breaks away from the moving coil, or the fine wire from the moving coil may have been broken.

To make any solder repairs in these areas requires a very fine pointed pencil soldering iron. If this is not available, a wire added to a regular soldering iron tip, as shown in Figure 8, will work. No disassembly of the meter movement should be attempted because it has been delicately adjusted to provide a specific full scale deflection for a measured current input. Carefully maneuver the tip of the soldering iron to the control spring or moving coil wire in place. The meter shown in Figure 8 was repaired in this manner.

No disassembly of the meter movement should be attempted because it has been delicately adjusted to provide specific deflection.

# TEST INSTRUMENTS Lowest Prices Off-The-Shelf Directly To You

## HITACHI 35 MHz DUAL TRACE OSCILLOSCOPE

Model V-355  
**\$599<sup>95</sup>**

(Reg. \$899.95)  
Probes included.



- Thin, lightweight, compact • Large 6" rectangular, internal graticule CRT
- Autofocus

**LOGIC PROBE  
BP LP189  
(\$40.00 VALUE)**  
with purchase of  
Model V-355

**FREE!**

## FORDHAM 550 MHz FREQUENCY COUNTER

Model FM-8  
**\$169<sup>95</sup>**

(Reg. \$249.95)

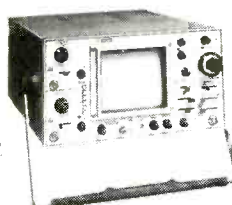


Completely assembled, pre-tested, pre-calibrated • High intensity 8-digit LED display

## B&K 60 MHz TRIPLE TRACE OSCILLOSCOPE

Model 1560  
**\$899<sup>95</sup>**

(Reg. \$1150)  
Probes included.



- 1 mV/div sensitivity
- 22 calibrated
- sweeps • Rectangular CRT
- w/internal graticule & scale illumination • Autofocus

## FLUKE 3½ DIGIT MULTIMETERS & VOLTMETERS

Model 73 **\$74<sup>95</sup>**

Model 75 **\$89<sup>95</sup>**

Model 77-F **\$119<sup>95</sup>**



## FORDHAM SWEEP FUNCTION GENERATOR

Model FG-801  
**\$199<sup>95</sup>**

(Reg. \$289.95)  
Test Leads included.



**SPECIAL PRICE!**

- 7 frequency ranges, 0.2 Hz to 2 MHz
- Accuracy to ±5%

## HITACHI 100 MHz QUAD TRACE DELAYED SWEEP OSCILLOSCOPE

Model V-1050F  
**\$1249<sup>95</sup>**

(Reg. \$1980)  
Probes included.



- Large 6" rectangular CRT w/internal graticule
- Delayed alternate and single sweep functions
- Autofocus

☎ ☎ ☎ Phone orders accepted.

**Fordham** **800-645-9518**  
260 Motor Parkway, Hauppauge, NY 11788 **In NY State 800-832-1446**

**ASK FOR OUR  
FREE CATALOG!**

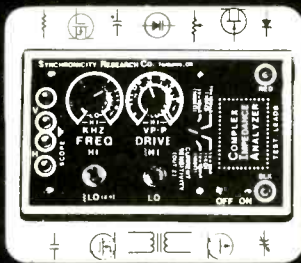
Toll Free

### Service & Shipping Charge Schedule Continental U.S.A.

FOR ORDERS	ADD
\$25-100	\$4.50
\$101-250	\$6.00
\$251-500	\$8.00
\$501-750	\$10.50
\$751-1,000	\$12.50
\$1,001-1500	\$16.50
\$1,501-2000	\$20.00
\$2,001 and Up	\$25.00

Circle (22) on Reply Card

## COMPLEX IMPEDANCE ANALYZER NEW



- ★ Speeds Up Field Service
- ★ Variable Freq & Drive
- ★ Tests Any Part - Quickly
- ★ Wide Z Range - CMOS Safe
- ★ Works IN or OUT of Circuit
- ★ Use With Any X-Y Scope

If you have always wanted a **REAL** component analyzer, but didn't want to shell out 1000's of \$, Order Your CIA Today!  
\$198<sup>00</sup> PPD to USA address

**SYNCHRONICITY RESEARCH CO.**

P.O. Box 153 405-628-3695  
TONKAWA, OK 74653

Circle (23) on Reply Card

## ATTENTION TECHNICIANS

- ★ JOB OPENINGS
- ★ MONTHLY TECHNICAL TRAINING PROGRAM
- ★ BUSINESS MANAGEMENT TRAINING
- ★ LOW COST INSURANCE
- ★ CERTIFICATION
- ★ TECHNICAL SEMINARS

All of this in a nonprofit international association for technicians

FIND OUT MORE:



604 N. Jackson St.  
Greencastle, IN 46135

A much simpler type of repair involves only the repositioning of the meter pivot. The battery tester meter movement, shown in Figure 9, was repaired by removing the pivot screw, centering the pivot point through the screw hole, and replacing the screw. A piece of tape was used to secure the meter pointer to the instrument face, preventing the pivot from moving as the screw was being replaced.

If meter movement repair is unsuccessful, new movements usually are available from the instrument manufacturer. Adding the price of the replacement movement to the marked down instrument price often yields a final cost lower than that of a new unit.

Digital multimeters also may prove to be simple to diagnose and repair. While the store where the \$15 *as-is* meter shown in Figure 10 indicated that the A/D converter was bad, it was noted that the reading would change as the range dial was rocked. Disassembly of the function switch showed little or no contact marks in some contact areas. Some mechanical adjustments to the switch contacts were all that was necessary to make the unit fully operational.

### Television sets

The decision to purchase this item is usually based upon price, if the picture tube is intact and no major assemblies are missing.

Different sets may be similar, especially when comparing brand names with department store models. In one case, the circuits in a Zenith and an XAM (sold by Korvettes) were similar enough to allow the use of the Zenith schematic to signal trace to a defective horizontal output transistor in the XAM set. Therefore, until the schematic for the set being repaired is obtained, one from a similar receiver may be used.

### Miscellaneous merchandise

Tape recorders, ac adaptors and small amplifiers also often are available. The same general evaluation and troubleshooting techniques apply to these items as well

as to those already discussed.

In the case of ac adaptors, wire breaks at the strain reliefs are generally the cause of failure. (See Figure 12.) Molded wire strain relief connections can be repaired by drilling out the broken wire from the strain relief and then rewiring it.

### Cosmetic repairs

Invisible cosmetic repairs can be made using a few easily obtainable items. Cracks, chipped corners or burn holes can be repaired by first smoothing down the surface with sandpaper (or a file), if necessary. Fill in deep holes and cracks with wood putty using a flat surface coated with water to smooth the putty as it is applied. After the putty has dried, it can be stained to match the equipment cabinet. To further disguise the repair, apply a coat of clear enamel paint to the whole cabinet.

Badly damaged surfaces can be hidden by covering them with a piece of plastic laminate like Formica. Wood-grained cabinets with damaged tops can be repaired easily in this manner. After the Formica is cut to size, and all holes for controls have been made, paint the cut edges to match adjacent cabinet surfaces.

Replacements for missing or damaged parts, when parts are not available from the manufacturer, can be fabricated from scrap pieces of wood, metal or plastic. Replacement clock hands can be cut from thin gauge metal and a face plate can be made from acrylic plastic with glued-on tabs to secure it to the instrument cabinet. Silver trim can be restored by using an artist's brush and silver model paint. The extent of possible cosmetic repairs is limited only by your imagination.

Careful selection of bargain-table merchandise not only will secure quality items at low prices but will improve your troubleshooting and repair skills.

Victor Meeldijk is the manager of the Reliability and Maintainability Dept. for Diagnostic/Retrieval Systems, Oakland, NJ.





Figure 10. Inspection of the function switch in this as-is faulty meter revealed that some contact areas showed no sign of rubbing. Mechanical adjustment of the contacts was all that was needed to make it work.

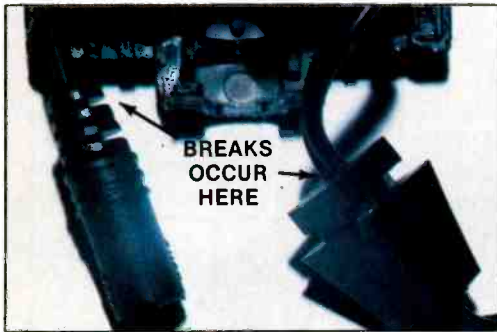










Figure 11. Strain reliefs on ac adaptors may break, causing electrical failure of the unit. This type of problem can be repaired simply by drilling out the broken wire and installing a new wire.

**ES&T** *m*

<b>FLYBACK TRANSFORMERS</b> Replacement for: SANYO  F-0260...\$11.00 F-1119...\$15.50 F-1108...\$11.00 4-2751-48500...\$ 7.50 4-2751-48600...\$ 7.50  SHARP/SAMPO 8FT-043-B...\$ 7.50 8FT-046...\$ 7.50	<b>POPULAR FOCUS BLOCK</b> Replacement for: SANYO/SEARS  Z20063UAA...\$9.50 Z20064UAA...\$9.50 Z20065UAA...\$9.50  <b>BATTERY TESTER</b> 9V, 1.5V & Button Batteries NBT-1...\$2.80  <b>DISTRIBUTION AMPLIFIER</b> VHF/UHF/FM KF-204...\$ 9.50
<b>THREE WAY SPIKE PROTECTOR</b> P-511...\$2.50	<b>HONDA TYPE CAR ANTENNA</b> NP-209Z...\$1.00 Min.3 Pcs.
<b>VCR/TV SIGNAL SEPARATOR</b> N3-73...\$ 0.70¢ 	<b>VIDEO TAPE REWINDER</b> VHS MPS-550VH...\$11.00 
<b>DESOLDERING GUN</b> 74B35...\$ 1.85 <b>DELUXE</b> 	<b>POWER SUPPLY REGULATED</b> DVP-212...\$18.00 DVP-612...\$28.00 
<b>AUDIO TECHNICA PHONO CARTRIDGE</b> AT-70...\$5.50 AT-3482...\$4.95 	<b>RG-58 COOPER BRAID COAXIAL CABLE/300 OHMS</b> RG-58...\$38.00 (1000 Ft Spools) SHIPPING CHARGE: \$5.00 Each Roll <b>RG-59 COAXIAL CABLE WHITE OR BLACK/75 OHMS</b> RG-59...\$38.00 (1000 Ft Spools) 
<b>NIPPON AMERICA INC.</b> ELECTRONIC SPARE PARTS 9600 N.W. 12 STREET MIAMI, FLORIDA 33172 TELEX: 568828 NIPPON AM MIA/FAX: (305) 591-0039 TEL: U.S.A. 1-800-327-7522/LOCAL (305) 592-2616 592-2618 CALL OR WRITE-C.O.D. ORDERS WELCOME (Min. Order \$25.00)	

Circle (24) on Reply Card

# LOOK THE SAME?



## YOU BET!

Outside of the improvement, you can't tell the difference!

- TOTALLY INTERCHANGEABLE WITH EDSYN® DS 047 AND AS 196 DESOLDERING HANDPUMPS
- LIST PRICE: DP-4: \$13.95 each; DP-5: \$14.25 each. (QUANTITY DISCOUNTS AVAILABLE)

### CALL YOUR LOCAL A.P.E. DISTRIBUTOR:

- (516) 654-1197
  - TWX: 510-228-2120
- 142 Peconic Avenue  
 Medford, N.Y. 11763



Circle (25) on Reply Card

# What do you know about electronics?

By Sam Wilson

It is easy to get caught up in the necessary priority of making a living and forget to take time to reflect on the clever things that electronics designers do. I want to give just one example because it ties in with one of the subjects to be discussed.

Components don't come in precise values. If you buy a resistor, it may have a 10% or 5% tolerance rating. If you want something more accurate, you will have to pay for it.

It is not usually necessary to consider the effect of temperature on resistance values as long as you stay within the manufacturer's power ratings.

Some types of ceramic capacitors have stated *temperature coefficients*. (You may be surprised to hear that ceramic capacitors were first introduced in the 1930s.)

Now for the clever design.

When an oscillator circuit is cold—that is, first energized—its frequency might be slightly different from its value at the normal operating temperature. The drift in frequency is mostly due to changes in component values with an increase in temperature.

If there is a change in *capacity* as the circuit temperature goes up, the designer can use a ceramic capacitor with a specific temperature coefficient to balance out that change. The overall result is that the oscillator frequency is relatively constant over a range of temperature values. It is essential that you be careful to use replacement ceramic capacitors having the same capacity *and* temperature coefficient.

Temperature coefficients are rated in *parts per million per degrees Celsius* (PPM/°C). As an example, one part per million per

degree Celsius represents a change of only 0.0001% in value.

A rating of N750 means that an increase in temperature of one degree results in a decrease in capacity of 750 parts per million per degree Celsius.

A rating of NPO means that the value is stable over a wide range of temperature values. P100 means that the value increases 100 parts per million when the temperature increases one degree Celsius.

Available values and related tolerances are given in Table I.

Table I

P100	NP0	N030
P030		N080
		N150
		N220
		N330
		N470
		N750
		N1500

Suppose you want to connect two ceramic capacitors in parallel, as shown in Figure 1, to get a higher capacity value. They have different temperature coefficients, and you want to know the temperature coefficient of the parallel capacitor combination. If you hadn't lost your April-May-June 1962 issue of the *Aerovox Research Worker*, you would be able to look up the following equation:

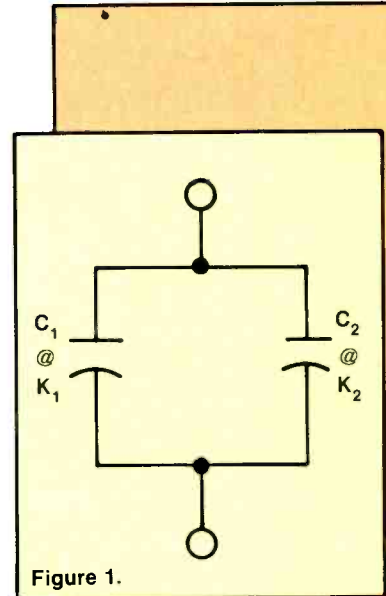
$$K_1 = \frac{1}{C_1 + C_2} [K_1 C_1 + K_2 C_2]$$

where  $C_1$  and  $K_1$  are the capacity and temperature coefficient of the first capacitor.

$C_2$  and  $K_2$  are the capacity and temperature coefficient of the second capacitor.

$K_1$  is the temperature coefficient of the combination.

The equation would be more



helpful if it were rearranged so that you can find the value of temperature coefficient you need in order to get some desired value. I've done that, and the result is given here:

$$K_2 = [K_1(C_1 + C_2) - K_2 C_2] / C_2$$

It is always a good idea to work a sample problem. We won't spend any time on getting the correct capacity value by connecting capacitors in parallel. That is a simple subtraction procedure. If you need 8, and you have 5, you must add 4. (I just wanted to make sure you are paying attention.)

## Sample problem

You need a 200pF capacity value with a temperature coefficient of N330. You have a number of 100pF capacitors with an N750 rating. So, you need to add a 100pF capacitor in parallel to get the required value of 200pF, but what temperature coefficient do you need?

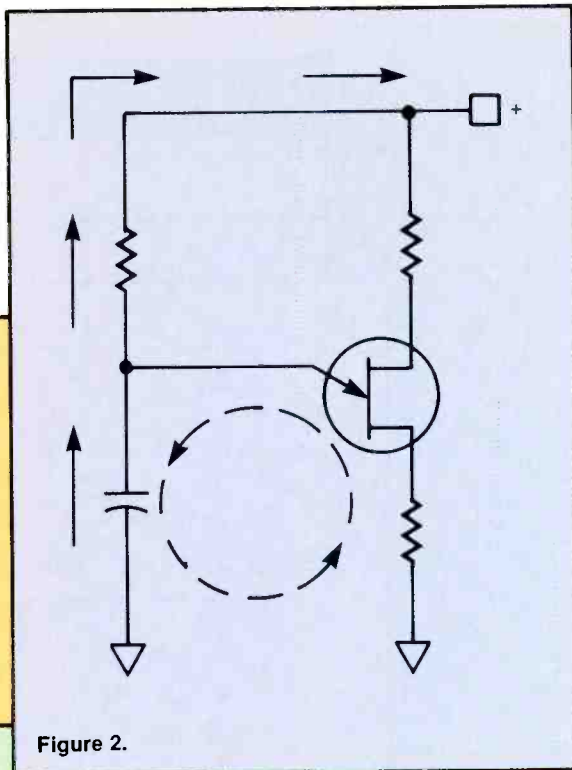


Figure 2.

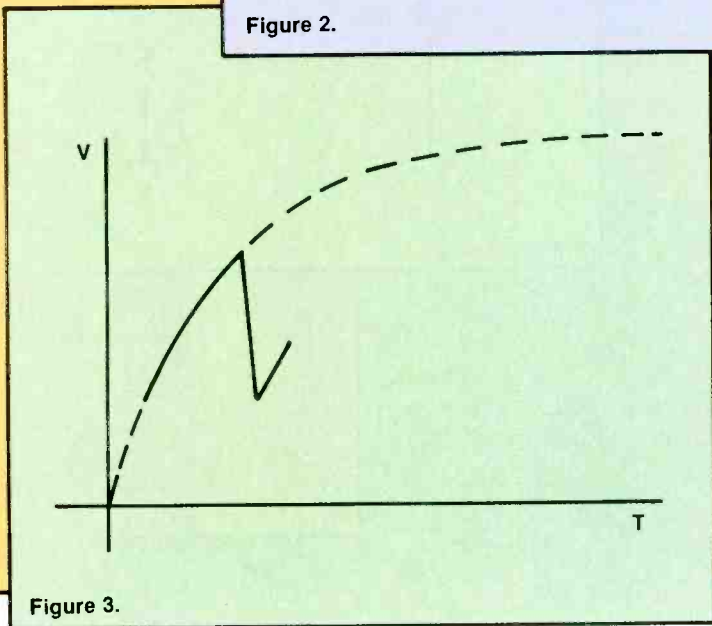


Figure 3.

**Solution**

Using the equation for  $K_2$  above, and filling in all the known values gives

$$K_2 = \frac{[-330(100 + 100) - 100(-750)]}{100} = 90$$

Use a capacitor with temperature coefficient of P100 to get a close approximation to the required value.

If you have a programmable calculator or computer it is an easy

matter to get the equation into memory. That way, you just fill in the known values.

**The constant-current diode**

Relaxation oscillators generate non-sinusoidal waveforms. Their frequencies depend upon the time constant of an R-L or R-C circuit.

Figure 2 shows a simple UJT relaxation oscillator. The capacitor charges through R (solid arrows) and discharges through the UJT (broken arrows). The ramp voltage is not linear. It follows an R-C time constant curve shown in Figure 3.

The reason for the curvature is

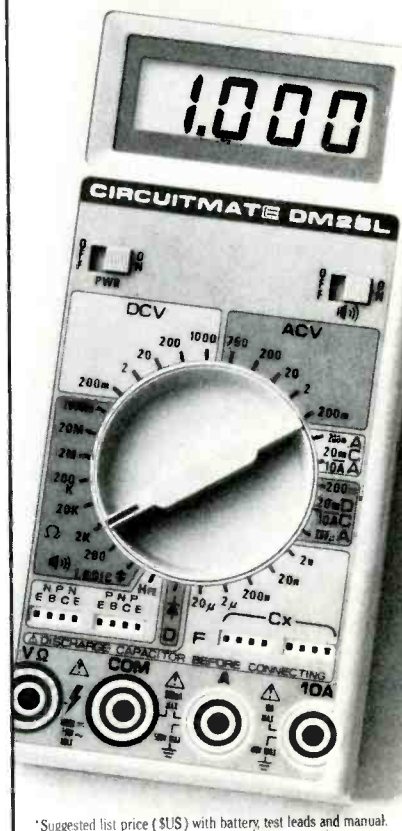
# Capacitance, logic and more. For less.

Now, a fully-loaded DMM combines a capacitance meter, logic probe, and an hFE meter, all for the price of a DMM.

- TTL Logic Probe: 20 MHz
- Hi/lo/off indications
- Detects 25nS pulse width
- Capacitance: 5 ranges (2nF to 20μF)
- hFE (NPN or PNP): 1 range (1000)
- DMM: DCV-5 ranges (.2V to 1kV)
- ACV-5 ranges (.2V to 750V)
- DCA-4 ranges (200μA to 10A)
- ACA-3 ranges (20mA to 10A)
- Ohms-7 ranges (200 Ohms to 2000 Megohms)
- Continuity beeper
- Diode check
- Built-in bail
- Anti-skid pads

See one now at your local Beckman Industrial distributor.

**DM25L... \$89<sup>95</sup>\***



\*Suggested list price (\$US) with battery, test leads and manual.

**Beckman Industrial™**

Beckman Industrial Corporation  
A Subsidiary of Emerson Electric Company  
630 Puente Street, Brea, CA 92621  
(714) 671-4800

© Copyright 1985 Beckman Industrial Corporation

Circle (26) on Reply Card

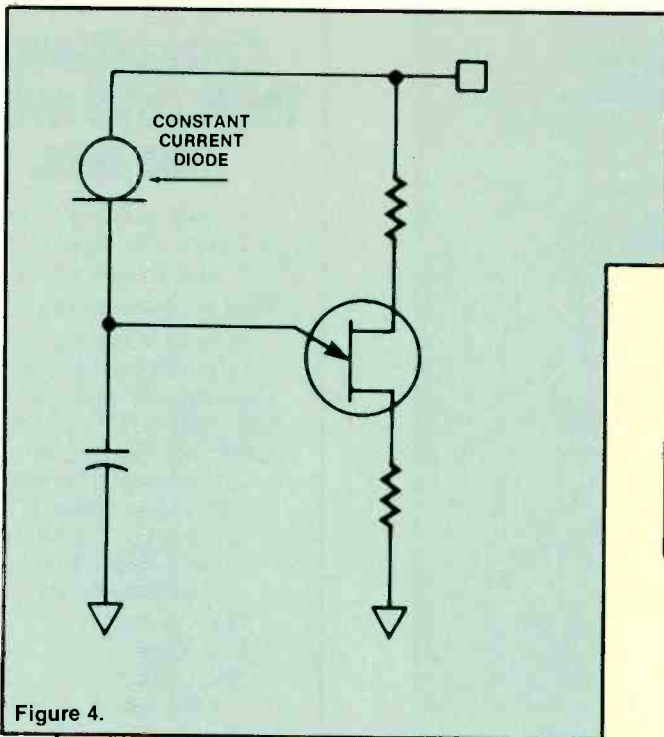


Figure 4.

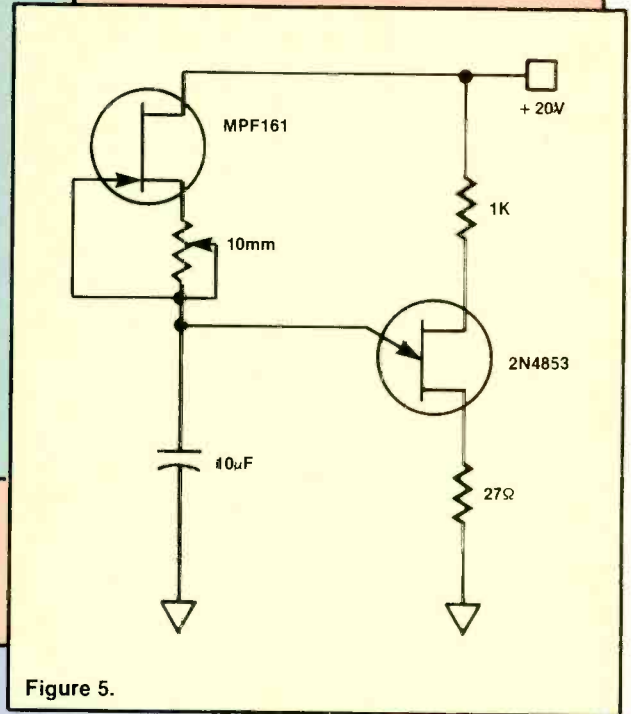


Figure 5.

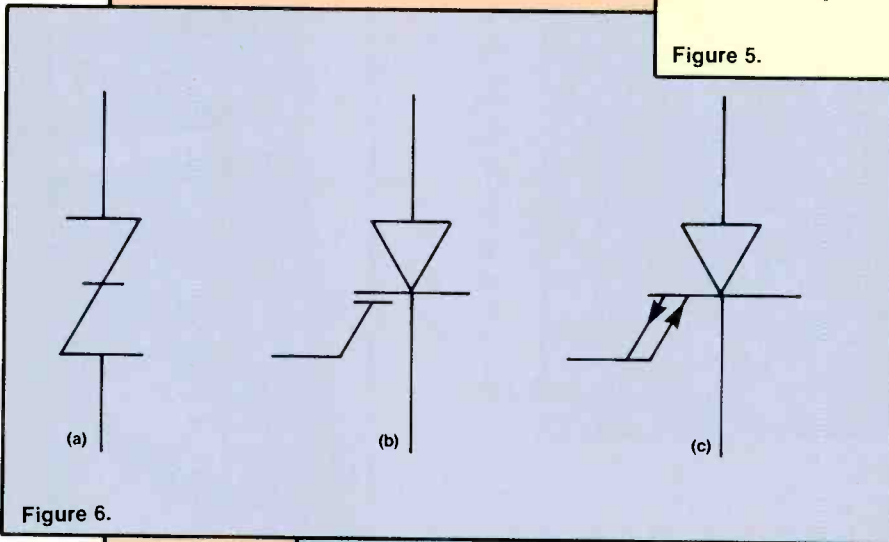


Figure 6.

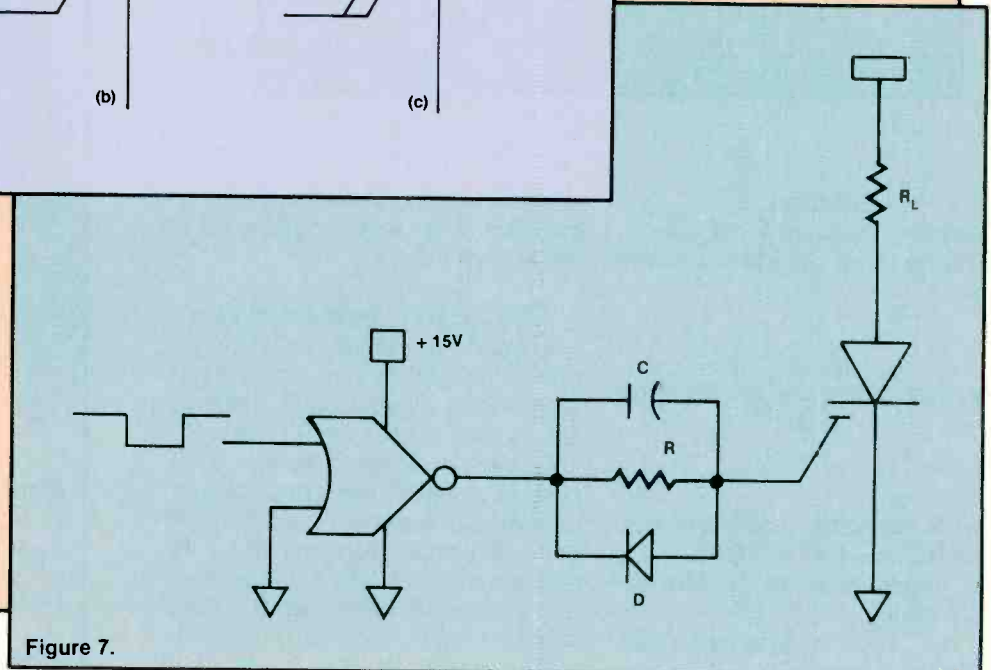


Figure 7.

that the rate of change of the charging current at any instant depends upon the *difference* between the applied voltage and the voltage across the capacitor. As the capacitor charges, the difference in the voltages decreases, and rate of change of the charging current decreases.

If you provide a constant current to the charging capacitor, you will find that the ramp will be linear because there is no longer any *rate of change* of the charging current. One way: Charge the capacitor through a *constant-current* diode as shown in Figure 4.

Dan Loper is my lab assistant. I asked him to build the circuit of Figure 4 and make some tests because I wanted to use it in a lab manual that I was writing. He made an extensive search for the constant-current diode, creating a

very healthy phone bill as he went, but could not locate a supplier who would send us just one. We could get 5,000, or 10,000, but not one.

You will see these diodes on schematics, so I assume there must be a method of buying one for replacement, but we were both unsuccessful in our search.

Dan hasn't learned the word "no". He found the circuit of Figure 5 in a Motorola manual. The point is that *you can make your own constant-current diode* if you need one for replacement and you can't find one! You will need a JFET and a resistor.

### Keeping up with the symbols

Go to the head of the class if you can name all three of the components symbolized in Figure 6.

The one in Figure 6(a) is not a zener diode but it looks like it could be. *Sidac* is its name.

Observe that you can change the letters of the name around and get the name *diac* with an extra S left

over. Like the diac, it is a 2-terminal breakover device. Another way of saying that is *bilateral trigger*.

Do we really need this if we already have diacs? The answer to that question is YES. Even the smaller versions of the sidac have higher voltage and current ratings than diacs.

For example, Motorola's MK1V-125 has a repetitive breakover voltage in the 110V to 125V range. It can handle rms currents of 1A, and surges up to 20A.

The symbol in Figure 6(b) represents a MOS SCR. You will remember that an ordinary SCR requires a gate *current* to get it into conduction. The MOS SCR is voltage operated. For that reason, *it can be triggered on by the output voltage of an integrated circuit logic gate*.

Some examples of this component are the Motorola MCR1000-4, -6 and -8.

*Continued on page 59*

## EVERYBODY'S A WINNER!

At the National  
Professional  
Electronics  
Convention



Informative Speakers  
Management Seminars  
Technical Training  
Sponsored Meals  
Tennis / Golf Tournaments

Sponsored by the National Electronics Sales & Service Dealers Association & the International Society of Certified Electronics Technicians

LAS VEGAS . TROPICANA . AUG. 4-9

\*Send for more information and an application to  
NPEC, 2708 W. Berry St., Ft. Worth, TX 76109. Ph (817) 921-9061

Name \_\_\_\_\_

Address \_\_\_\_\_

City \_\_\_\_\_ State \_\_\_\_\_ Zip \_\_\_\_\_

## HIGH VOLTAGE TRIPLERS/MULTIPLIERS

REPLACEMENT FOR

### ECG®/GE®/SK®

500A/GE527 & SK3304	8.75	6.95
523/GE528 & SK3306	8.85	7.20
526A/SK3306	8.85	7.20
528/SK3906	10.70	8.70
529/GE529 & SK3307	9.99 3 MIN.	7.95 100 MIN.

## OUTPUT TRANSISTORS

165/SK3115 & GE38	2.25	1.95	1.75
238/GE37 & SK3710	2.25	1.95	1.75
283/SK3467	2.75	2.35	1.80
2SD1341P	2.25	1.95	1.75
2SC1172B	2.25 5 MIN.	1.95 50 MIN.	1.55 100 MIN.

## AUDIO POWER

TYPE	10 min	50 min	100 min	TYPE	10 min	50 min	100 min	TYPE	10 min	50 min	100 min
152/SK3893	.30	.25	.21	196/SK3054	.49	.44	.39	291/SK3440	.49	.44	.39
153/SK3274	.30	.25	.21	197/SK3083	.59	.54	.49	292/SK3441	.49	.45	.40

## RECTIFIER DIODES

125	1000V/2.5A	7c	6c	5c
156	1000V/5A	18c	16c	13c
506	DAMPER/HI-VOLT—FAST RECOVERY	29c	24c	19c

## \$\$\$ ADDITIONAL SAVINGS \$\$\$

TYPE	10 min	50 min	100 min	TYPE	10 min	50 min	100 min
102A	.35	.32	.29	171	.49	.44	.38
123A	.18	.16	.14	184	.38	.33	.28
123AP	.13	.11	.09	185	.38	.33	.28
128	.38	.35	.29	198	.60	.54	.49
129	.38	.35	.29	199	.18	.15	.12
130	.59	.55	.49	234	.19	.16	.13
159	.16	.13	.11	375	.44	.42	.39
162	2.25	1.95	1.49	712	.75	.69	.60
163A	2.35	1.99	1.55				

FOR A COMPLETE LIST CALL OR WRITE—C.O.D. Orders Welcome (Min. Order \$25)

### DIGITRON ELECTRONICS

110 HILLSIDE AVENUE, SPRINGFIELD, NEW JERSEY 07081

Toll Free 1-800-526-4928 IN NJ 201-379-9016 Telex 138441

PRICES SUBJECT TO CHANGE WITHOUT NOTICE. OFFER GOOD WHILE SUPPLY LASTS. ECG is a Trade Mark of Phillips ECG, Digitron Ele. not associated with Phillips ECG.

Circle (27) on Reply Card

# Readers' Exchange

**For Sale:** Used modules and parts for the following - Admiral M10, M25; Magnavox T979, T995; Philco 4CY90; Quasar T915, T934; RCA CTC 59, 74; Sears 528.4195; Zenith D, E, F. Also GE L2, HC, HE, H4 chassis parts. **Wanted:** Book 2 of the 10 books that Hawkins Electrical Guide published 1917, revised 2nd edition. State price. **Needed:** Good, used fly for color GE, part No. EP77X30. *D. J. Ajjala, 50 Fir Circle, Babbitt, MN 55706.*

**Wanted:** Sams Photofact CB Radio series - issues No. 158, 170, 180, 187, 190, 207, 219, 221, 229 and 251. **For Sale:** Sams Photofact CB Radio series - issues No. 35, 59, 72, 74 to 78, 87, 112, 120, 168 and 288. *S.H. Zagar, Swan Lake Enterprises, Box 384, Pengilly, MN 55775; 218-885-2710.*

**Wanted:** Good, used 310FDBP4 B&W CRT (original from Panasonic model TR542). Also need good, used RCA vertical module MAG005A from model AT122W, chassis KCS 193A. *Mike Danish, P.O. Box 217, Aberdeen Proving Ground, MD 21005; 301-272-4984, evenings.*

**Wanted:** Parts for Garrard record changer model 60MKII; volume 20 of Riders Troubleshooter manual in good, clean condition. Send price and shipping charges. *Paul Capito, 637 W. 21 St., Erie, PA 16502.*

**For Sale:** Tektronix 105 square-wave generator, \$45; HP 400H ACVTVM, \$85; HP 410B VTVM, \$90; Heath IG-5240 bar-dot generator, \$55; Heath ACVTVM, \$25; Sencore TF-151 transistor tester, \$35; Fluke 802A digital multimeter and leather case, \$75. Offers considered. *Danny Schultz, P.O. Box 1823, Arcadia, FL 33821; 813-494-3118.*

**Wanted:** CB radio schematic/servicing manual by Tab Books; service manual for a Jerrold wireless TV converter, model DRV-3C-105; service manual for an Ibanez tube screamer, model TSI9 (used by guitar players); *Electronic Servicing and Technology* magazines, back issues from August 1981 to date; service manual for a Motorola CB radio, model CB 1136. *RéJean Mathieu, VE-2-EUI, 1897 - Third Ave., Val D'Or, Quebec J9P 4N7, Canada.*

**Wanted:** Supreme radio manuals, volume 1 and volume 17. *Arnold G. Schmidt, Route 5, Jamestown, ND 58401.*

**Wanted:** NRI Discovery Lab, NRI model W VTVM and NRI model 240 VOM. *William P. Jarvis, 1214 Fifth Ave., Beaver Falls, PA 15010; 412-846-7735.*

**For Sale:** Complete Sams Photofacts folders No. 404 through No. 750. Best offer. **Wanted:** Z-meter at reasonable price. *Joe Loesch, Loesch Electronic Service, Route 1, Box 121, Kimball, MN 55353; 612-398-5167.*

**Wanted:** TV sound tuners (Conrac, Lafayette); Sams AR 243, 252, 255, 262, 266, 293, 299, 300; Creative Electronic's ESR meters. *Jim Farago, P.O. Box 65701, St. Paul, MN 55165.*

**For Sale:** Text books, service manuals, yokes, flybacks, assorted parts, 1,000 tubes at 80% off list price, test equipment. Send s.a.s.e. for list. *M. Seligsohn, 1455 55th St., Brooklyn, NY 11219.*

**Needed:** Schematic for Roberts tape recorder, model 1040. Will buy or copy and return. Will buy used one for parts; state price. *Cleo Zarella, 937 Center St., Brockton, MA 02402.*

**For Sale:** B&K model 415 sweep/marker, like new, all manuals, leads, probes, etc., \$250. Send cashier's check and we will ship UPS, c.o.d. in original cartons. *George W. Crouch, Ace TV & Electronics, 4018 Lillian Drive, Concord, CA 94521; 415-682-8841.*

**Wanted:** Game cartridge edge connector for Vectrex Arcade system, model HP3000 or source for parts. *Mackenzie TV, 1800 N. Scottsdale Road, Scottsdale, AZ 85257; 602-946-7270.*

**Wanted:** Weller temperature-controlled soldering irons (part numbers TC201, TC201P, TC201Z and TC201PZ) for use with WTCPN/WTCPR soldering stations. Irons need not be working; prices must be reasonable. Reply indicating quantity and part number(s) you have, prices and condition. *Dave, P.O. Box 151, Poway, CA 92064.*

**For Sale:** Sencore SC61 waveform analyzer, complete, \$2,500; Sencore VA62 video analyzer with NT64 and VC63, complete, \$2,850, or both for \$5,000; Sencore TF151 transistor checker, \$50; Sencore CR31A CRT tester, \$150; B&K 1460 scope, \$125. Many other items; send s.a.s.e. for list and prices. *Jim Frost, Jim's Television Service, 95 S. Wintzell Ave., Bayou LaBatre, AL 36509; 205-824-2262.*

**For Sale:** RCA oscilloscope, triggered wideband WO-535A, like new, \$100; 625 TV tubes without boxes, \$150; Tekfax 105, 109, 110, 111, 112, 113, 114, 115. *Douglas Haustein, 94 Wimans Ave. Cranford NJ 07016.*

**Wanted:** Meter, Triplett model 630, type 3. *Troy Steen, P.O. 271, Morgantown, IN 46160.*

**Wanted:** NTSC color-bar generator; VHS and Beta alignment tapes; tape-tension gauge. Must be affordable and workable. *A.J.'s Electronics, 507B Herbert St., Port Orange, FL 32019; 904-767-0672.*

**Needed:** Schematic for Newcomb amplifier, model E75, good, used metal detector, White, not too old; audio output transformer, 4-8-15, 70V lines, 25W to 30W, fed by 26L6. *Lew Wollaston, Wollaston Radio & TV, 1504 Big Horn, Alliance, NE 69301.*

**For Sale:** Tubes - I have what you want, or will find them. Send list for quote. *Ted Youngman, 2225 Vigo St., Lake Station, IN 46405.*

**For Sale:** New Hitachi oscilloscope, V-355, 35MHz dual trace, \$450; B&K TV analyzer, model 1077B, \$150; B&K 1248 color generator, \$150; Mark V HV scanner, never used, \$650; Mark III HV scanner, never used, \$400; B&K 470 CRT tester/rejuvenator, \$150. All test equipment in good condition, with manuals and test leads. Mark V and III still in box. Owner retiring. *Roy Morgan, Morgan Electronics, Palacios, TX 77465; 512-972-3482.*

**Wanted:** 19-inch color CRT, No. 19VJFP22, or equivalent, for Supre-Macy ZOMK chassis No. ECC-20297, by Teknika. *Willon Taylor Jr., 1826 Clement Ave., Apt. 19, Charleston, SC 29405; 803-556-5012.*

**For Sale:** RCA crystal calibrated marker; generator WR-99A; sweep generator WR-69A; marker adder WR-70A. Make offer. *Oliver Luoma, 658 Heritage Trail, Gilbert, MN 55741; 218-865-6828.*

**For Sale:** Hewlett-Packard 608D-TS510A/U RF signal generator, 10-420MHz, with manual, \$425; Hewlett-Packard 400D audio VTVM, \$85; Hewlett-Packard 522B frequency counter, 10-120kHz, with manual, \$150; International C12B portable service monitor, CB frequency meter-power-modulation and signal generator, with manual, \$135. Equipment has been tested. Other items, some new. Prices do not include shipping. *Art DeMario, P.O. Box 162234, Miami, FL; 305-893-6932.*

**For Sale:** Sylvania kits for CK-3000 color test jig; K606 GE adapters, K611 Motorola adapters, \$25 each set. *Keith's Sound Service, 13 Sand St., Philadelphia, NY 13678; 315-642-3419.*

**For Sale:** B&K model 1077B, new condition, with manuals, \$150; Sylvania CK3000, color test jig, new in original carton, with manuals and adapters, \$50; B&K model 415 IF alignment generator, \$100; B&K model 2040 and 1040 CB service master, \$100; B&K model 970 radio analyst, \$25; RCA model 541a channelist, \$25. *Roy Brody, Roan Electronics, 65-56 Fresh Meadow Lane, Fresh Meadow, NY 11365; 718-461-1888.*

**For Sale:** Tektronix 2236 scope with probes, mint condition, \$1,550; B&K 1590 scope with probes, mint condition, \$1,150. *Dwight's Electronics, 9875 Pulte Drive, Salida, CO 81201; 303-539-7571.*

**For Sale:** B&K tube tester, model 707, \$75; Telematic tuner-subber KT730, \$50; Sencore ringer YF33, \$75; B&K analyst, No. 1076, \$100; Sencore multimeter, \$25; high-voltage probe, \$10; assorted modules. *Elmwood TV, Inc., 136 Market Square, Newington, CT 06111; 203-666-1990.*

**Needed:** Owner manuals for LectroTech TO-55 scope and SMG-39 sweep marker generator. Will photocopy and return. *Warren Mitchell, 1500 Jackson, Quincy, IL 62301.*

**Wanted:** Schematic for Olson model RA195. *Diversified Electronics, 1505 Menlough Drive NW, Canton, OH 44708.*

**For Sale:** B&K TV alignment generator, model 415. *Alvin Jacobson, 416 W. Second St., Williston, ND 58801; 701-572-5712.*

**For Sale:** Rider radio manuals, No. 1 through No. 14, \$5 each; 250 Sams manuals, \$1 each. Prices plus shipping. TV shop test equipment, send for list. **Wanted:** IM-2410 Heath frequency counter. *Ralph Dorrough, 117 Pecan St., Terrell, TX; 214-563-7105.*

**Wanted:** TV picture tube rebuilder for years 1975 to 1986, Sylvania color TV E10 chassis; TV troubleshooting tips on color TV shutdown circuits. *James E. Gregorich, 117 Second St. North, Virginia, MN 55792; 218-749-4355.*

**For Sale:** RCA color jig with cables and books, \$25; B&K model 1077B TV analyst with accessories, \$200; Heath model IG57A generator sweep/post marker, \$75; Pomona HV probe, 30kVdc, \$15. *John Gorman, 210 Sprague Ave., South Plainfield, NJ 07080.*

**For Sale:** New CRT, Hitachi 5DEP1(F), make offer. **Needed:** Schematic and any repair information on Nordmende Radio Globetraveler Pro 74 (not Globetrotter). Will buy, or copy and return. *Loree Electronics, 10614 80th Ave. E, Puyallup, WA 98373.*

**ES&T**

Continued from page 57

Figure 7 shows an example of a CMOS NOR gate being used to trigger the MOS SCR. The combination of capacitor, resistor and diode are called the *gate-limiting impedance* by Motorola. They show this circuit on their specification sheet for the MOS SCR.

The diode in Figure 7 is used to lower the gate-to-cathode impedance of the thyristor. That is necessary to improve the ability of the thyristor to block a forward voltage that may be applied when no conduction is supposed to take place.

The speedup capacitor and the resistor form an isolation impedance that prevents undesired triggering of the device.

You won't see Motorola's recommended isolation impedance circuit in every MOS SCR applica-

tion. As an alternative, you may see a simple resistive divider network.

The symbol in Figure 6(c) represents a gate turnoff device. Its operation can be compared to that of an SCR. You will remember that a short-duration pulse delivered to the SCR gate can be used to start conduction in the forward direction. Once conduction is started, the gate no longer has any control over conduction; and, it cannot be used to turn off the SCR.

The GTO can be shut off by delivering a negative voltage to its gate. That is what makes it different from the SCR.

I want to thank Motorola for supplying some of the technical information in this article.

Thanks also for those of you who take time to write. Your letters are important to us.

ES&T

REPRINTS

Interested in ordering article reprints out of this or another issue? \* Reprints can be excellent learning tools for your technical staff and great marketing tools for your sales staff. Call or write Kelly Hawthorne at Intertec Publishing Corp., P.O. Box 12901, Overland Park, KS 66212; (913) 888-4664.

\* Minimum order 1,000 copies

## MAKE ANY TELEVISION OUTPUT STEREO SOUND!!

Increase your profit margins by selling and installing this unique device.



Model SS-2001: The TELEVONIC™ implant unit, installed directly into any Television, creates synthesized stereo output from any channel. When connected with a stereo amplifier or receiver, it will provide a sound system found only in expensive stereo Televisions, at a fraction of the cost.

Works on any TV • Easy to install • 100% Solid State • Microchip technology • Superior Sound quality • 1 year warranty.

REQUIRES QUALIFIED TECHNICAL INSTALLATION.  
DISTRIBUTOR INQUIRIES WELCOMED.

For Information Contact: Mr. Ernest C. Hassell • Director of Marketing  
• Spectrum 2000, Inc. • 4854 Sterling Drive • Boulder, CO 80301  
• 1-800-922-6333

TELEVONIC is a trademark of Spectrum 2000, Inc.  
Manufactured in the U.S.A. by Spectrum 2000, Inc.

Circle (38) on Reply Card

## CONNECTION PROTECTION

SWITCHES & RELAYS  
CONNECTING CABLES  
EDGE CONNECTORS  
TERMINAL STRIPS  
PLUGS & SOCKETS  
GOLD PLATED CONNECTORS  
POTENTIOMETERS  
BATTERY CONTACTS



**CRAMOLIN®**

Even the finest equipment in the world cannot guarantee noise-free operation. One "dirty" connection anywhere in the electrical path can cause unwanted noise or signal loss.

"MORE THAN A CONTACT CLEANER"

**CRAMOLIN®** is a fast-acting, anti-oxidizing lubricant that cleans and preserves all metal surfaces, including gold.

When applied to metal contacts and connectors, **CRAMOLIN®** removes resistive oxides as it forms a protective molecular layer that adheres to the metal surfaces and maintains maximum electrical conductivity.

**CRAMOLIN®** - USED BY THOSE WHO DEMAND THE BEST:

Bell & Howell	Hewlett Packard	MCI(Sony)	Nakamichi
Capitol Records	John Fluke Mfg.	Motorola	RCA
Dolby Laboratories	McIntosh Labs	NASA	Switchcraft
			SINCE 1956

**CAIG LABORATORIES INC**

1175-O Industrial Ave., (P.O. Box J) - Escondido, CA 92025-0051 U.S.A. • (619) 743-7143

Circle (28) on Reply Card

## Literature

An illustrated "Tech Shield" brochure, available from **Brooks Tech**, describes a spray-on or brush-on, clear rubber protective transparent coating. The brochure explains that the coating protects metal, wood, composites, painted surfaces, concrete, plastics, fabrics and electrical/electronic connections against water damage, rust and oxidation, corrosion, ozone, ultraviolet radiation and electrical-current leakage.

The brochure lists acids, sea water, brine, caustic, chlorine, alcohol, water and acid rain as among the agents that Tech Shield coating will resist. Testing conducted on the coating is described. The brochure states "Only lack of imagination will limit the potential uses and applications of this material." Detailed coating specifications are presented.

Circle (125) on Reply Card

**M.M. Newman** provides detailed descriptions of its Antex soldering irons and equipment in an 8-page, full-color catalog that recently has been released. Included are specifications of miniature and heavier-duty soldering accouterments, and Kwik-Wik flux impregnated braid for desoldering purposes.

Circle (126) on Reply Card

Photos and specifications of **Spanta's** complete line of precision electrical measuring instruments are presented in a fact-filled brochure that is printed on card stock for ease in filing and repeated reference. Consult this brochure for general information; detailed brochures on each instrument also are available.

Circle (127) on Reply Card

**AEMC's** 1986 catalog of electrical and electronic test and measurement equipment is available. The catalog covers product features, applications and specifications for the test instrument line and related instruments. An extensive applications section is incorporated.

New products of special interest include the **ANAGRAF** series of autoranging analog/digital multimeters; a digital ground resistance tester for measuring very low resistance on large grounding systems; digital versions of the rubber-encased "Bouncer" multimeter series; dc and ac/dc clamp-on current probes and thermocouple sensors.

Circle (128) on Reply Card

**RCA's** catalog of nearly 200 accessories and installation hardware for all brands of video-related products has been updated for 1986.

The full-color, 42-page catalog features a new section devoted to camcorder accessories. Other product lines described and pictured include rugged cases for VCRs, cameras for carrying convenience and other associated items. This catalog also provides several charts to cross-reference camera and VCR accessories as well as camera and VCR replacements for RCA instruments.

Circle (129) on Reply Card

**ES&T**

## Books

*Editor's note: Periodically **Electronic Servicing & Technology** features books dealing with subjects of interest to our readers. Please direct inquiries and orders to the publisher at the address given, rather than to us.*

**Sams/TI Basic Electricity Series, acquired from Texas Instruments by Howard W. Sams, a division of Macmillan, Inc.;** three hardbound books, lab manuals and an optional course, all as described below:

- **Basic Electricity and DC Circuits, 2nd edition; 921 pages, \$19.95 hardbound**—This entry-level book reveals concepts, terms, formulas and related mathematics needed by beginners.

- Audio course, supplementary to above, \$14.95.

- **Basic AC Circuits; 560 pages, \$19.95 hardbound**—Continuing the step-by-step approach to understanding the principles, with a focus on formulas associated with the theory of operation, this book details the learning objectives and provides ample illustrated examples, practice problems and quizzes.

- Lab manuals for the above books, \$12 each, paperback.

- **Basic Electronics Technology; 464 pages, \$19.95 hardbound**—As an overview of analog and digital electronics based on semiconductor devices and integrated circuits, this book covers technology from fundamental concepts for beginners to advanced theory for seasoned practitioners.

Published by Howard W. Sams & Company, 4300 W. 62nd St., Indianapolis, IN 46268.

- **How to Read Schematics, 4th edition, by Donald E. Herrington; Howard W. Sams; 272 pages, \$14.95 paperback.**

If schematics are a mystery, this is a key. The new edition has been

revised and expanded to include the latest electronic developments, with logic diagrams and flowcharts included.

Published by Howard W. Sams & Company, 4300 W. 62nd St., Indianapolis, IN 46268.

- **Successful Sound System Operation, by F. Alton Everest; Tab Books; 336 pages, \$17.95 paperback.**

The author, a professional acoustics consultant and audio engineer, focuses on the sound system operator (rather than equipment) as the critical element in successful audio sound. Starting with background information on the physical nature of sound and sound waves, Everest guides readers toward maximum performance by encouraging their knowledgeable coordination of every component in a sound system. Besides equipment usage, there are in-depth details regarding state-of-the-art digital equipment that can facilitate wiser selection of new components.

Published by Tab Books, Inc., Blue Springs Summit, PA 17214.

**ES&T**



# Products

## Satellite test and troubleshooter

*Satellite Test Equipment* introduces the ET-15 satellite system troubleshooter and test set. The ET-15 allows a person with a minimal technical background to



troubleshoot a satellite system in 15 minutes or less, according to the manufacturer. The micro-processor controlled test set produces all the signals required at the following frequencies: K-band 12GHz, C-band 4GHz, and most single and block IF frequencies.

The internally generated color bar test pattern can be customized to include names and promotional messages and is available in PAL, SECAM and NTSC standards. The ET-15 also tests LNAs, LNBs, downconverters, polarizers, cables and splitters, and has a signal strength meter and continuity tester. It will accept an external video source.

Circle (75) on Reply Card

## Electrostatic locator

From ACL comes the model 300B precision electrostatic locator, which detects and measures



electrostatic build-up in a broad spectrum of static-sensitive locations. No auxiliary attenuators or heads are required; the ACL 300B is hand-held and self-contained. The low range measures 0V to 500V at 0.5 inches to the surface being measured, and 0V to 3,000V at four inches. For repetitive measurements, there is a function that instantly zeroes the instrument and provides ground compensation for the user.

Circle (76) on Reply Card

## Soldering/desoldering station for SMD technology

*Jensen Tools* recommends its new hot air soldering/desoldering station for work on SMD/surface mount devices. Completely portable and self contained, it is fast and efficient in removing and replacing DIP and Flat-Pack ICs, and adapts equally well to any standard PCB construction, according to the manufacturer.

This station features a 70W, hot air soldering/desoldering tool with adjustable temperature from 400°F to 800°F, and turbo-style tip. Leakage from tip to ground is

## OPTIMA ELECTRONICS

TO ORDER CALL TOLL FREE 1-800-327-0224

MINIMUM ORDER \$75.00

### Component Parts Sale

- 2SC1172B Toshiba — Rep. ECG238 ..... \$1.69 ea. min. 50
- 2SC1358 NEC — Rep. ECG165 ..... \$1.25 ea. min. 20
- 2SD1398 — (8-729-387-36) ..... \$2.50 ea. min. 5
- 2SC1114 ..... \$3.95 ea. min. 5
- 2SC1116 ..... \$3.95 ea. min. 5
- MN8303 (8-729-383-03) ..... \$3.95 ea. min. 5
- U05G (8-719-911-55) ..... \$1.25 ea. min. 5
- V11N (8-719-901-19) ..... \$1.25 ea. min. 5
- 221-96 — Rep. ECG818 ..... \$2.95 ea. min. 5
- 221-132 — Rep. ECG863 ..... \$2.95 ea. min. 5
- 221-158-01 — Rep. ECG1231 ..... \$3.95 ea. min. 5
- 221-175-01 — Rep. ECG874 ..... \$6.95 each
- 221-179-01 — Rep. ECG873 ..... \$6.95 each
- 221-190 — Rep. ECG875 ..... \$6.95 each
- AN239 ..... \$6.99 each
- AN5310 ..... \$3.50 each
- HA1377A ..... \$2.50 ea. min. 5
- TDA2002V ..... \$1.25 ea. min. 5
- 2.5 Amp — 1000 PIV Rect. .... 100 for \$7.95/500 for \$30.00
- Rep. for ECG 506 ..... 30 for \$13.50
- PN2222A — Rep. ECG123AP ..... 100 for \$15.00
- 2SC2315 — Rep. ECG152 ..... 50 for \$15.00

### Fuses

- (Sorry — No Mix!)
- AGC Fuses ..... 100 for \$10.00
  - GJV Fuses ..... 100 for \$12.00
  - GMA Fuses ..... 100 for \$14.00

### Quantity Prices Available

Letters of credit and all checks placed on deposit with Barnett Bank, FL. Visa & Master Card accepted. Min. order \$75. FOB Dania, FL. Catalog available upon request.

SEND CHECK OR MONEY ORDER TO:

## OPTIMA ELECTRONICS

2022 Tigertail Blvd., Dania, FL 33004

Call Nationwide 1-800-327-0224 Local 305-920-3550

Circle (29) on Reply Card

## OPTIMA ELECTRONICS

TO ORDER CALL TOLL FREE 1-800-327-0224

MINIMUM ORDER \$75.00

### Needles & Cartridges — Call for literature & price sheet!

- Tetrad Cart. w/needle ..... \$2.75 ea. min. 10
- Shure M81MC Cart. w/needle ..... \$4.80 ea. min. 5

### Video Belt Kits — (Popular Numbers — call for literature & prices!)

#### Antennas

- AT10 Universal-Back of Set ..... 5 for \$12.00
- AT19 Panasonic, Di-Pole ..... 5 for \$19.95
- Rembrandt — Model #890, Top of Set ..... 5 for \$12.50
- Rembrandt Power King 900, Top of Set ..... \$8.40 ea. min. 6 pcs

#### Triplers & Dividers

- 523/526A ..... \$10.95 ea. min. 6
- Hi Divider 3 (800-616) ..... \$3.99 ea. min. 6
- Z0064-ESPA98 ..... \$9.99 ea. min. 4
- Z0040-ESPA91 ..... \$9.99 ea. min. 4
- Photo Cell for Remote Control ..... \$3.50 ea.
- Triac (185-9) ..... \$1.25 ea.

#### Capacitors — PC Mount

- Assort Values (12 pcs) @ 50V ..... \$3.25 each
- Assort Values (9 pcs) @ 160V ..... \$3.30 each
- Assort Values (8 pcs) @ 250V ..... \$3.95 each
- Assort Values (7 pcs) @ 350V ..... \$3.75 each
- Assort Values (5 pcs) @ 450V ..... \$2.95 each

#### Safety Caps

- Magnavox: 250663-11, -17, -19, -20 ..... \$3.95 ea. min. 10
- G.E.: 25 x60, x75, x78, x79, x90 ..... \$3.75 ea. min. 10

### Quantity Prices Available

Letters of credit and all checks placed on deposit with Barnett Bank, FL. Visa & Master Card accepted. Min. order \$75. FOB Dania, FL. Catalog available upon request.

SEND CHECK OR MONEY ORDER TO:

## OPTIMA ELECTRONICS

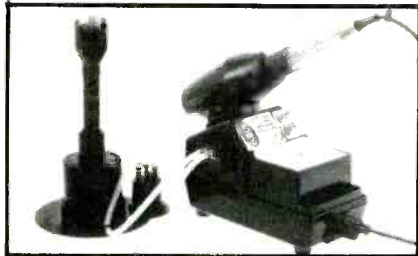
2022 Tigertail Blvd., Dania, FL 33004

Phone (305) 920-3550 TOLL FREE: 1-800-327-0224

Circle (30) on Reply Card

less than 2mV.

The 115Vac base features power-on and air pump switches (vacuum to 22-inch mercury), water reservoir, sponge with holder, tip tray and holding pod for hot air tool. An optional low-static, high-vacuum desoldering tool with valve control, long-life desoldering



tip and tool holder/cleaner with dual filters and reservoir is available.

Circle (77) on Reply Card

### Digital clamp-on VOA

Mercer Electronics, a division of Simpson Electric, is introducing a digital clamp-type ac volt-ohmmeter, the model 9701 digi-clamp. The digi-clamp will make



measurements up to 300A (two ranges), 2,000 $\Omega$  or 750Vac with basic accuracy of 0.8%.

Other features include 0.1A resolution, audible continuity indication and a data hold switch.

Circle (78) on Reply Card

### Cable tie tool

A compact, lightweight tool designed to speed the on-site installation of cable ties is being added to the LYNX/Catamount product line. Intended as a time saver for electronic and telecommunications installation and servicing, the QC-100 tensions the ties and then trims off the tails with a sim-

ple twist of the user's wrist. It also has many uses in hobby and home handyman applications.

Circle (79) on Reply Card

### Improved Z Meter

Sencore has announced an improved inductance-capacitor analyzer Z Meter II. The new meter reportedly checks capacitor value, leakage and dielectric absorption in less than half the time of the earlier model by doubling the



charge current. This feature is important when checking large electrolytics as used in computer filtering circuits. Capacitor tests are now more thorough with the addition of an equivalent series resistance (ESR) test. This is increasingly important as larger capacitors are used in high current, low voltage filtering circuits with low ripple requirements, such as in switching power supplies, AGC circuits, dc correction or sample and hold circuits and TV flyback transformer derived power supplies, the company stated.

Circle (80) on Reply Card

### Soldering temperature control

Precise temperature control at the iron tip can be maintained during production or repair with the new Thermolock line of soldering tools from Weller. By inserting a



specifically marked "key" into the handpiece, the tip temperature will be delivered within 10°F.

Each key element is precision calibrated and laser trimmed. The

element control can be changed by inserting another calibrated key of the desired temperature rating. The zero voltage circuit, driving a solid-state thyristor, eliminates switching transients on the iron tip that may interfere with operator production.

Circle (81) on Reply Card

### Identify unknown components

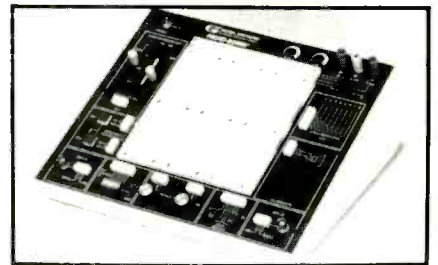
Philips Test & Measuring Instruments announces a microprocessor-controlled, fully automatic RCL meter with nine measuring modes. In its default mode, RCL Auto, the PM 6303 identifies the dominant resistive, capacitive or inductive characteristic of the component under test, indicating the magnitude, dimensions and also the effective equivalent circuit on a large LCD.

The microprocessor eliminates the need for manual tuning to obtain the final value, providing results with a 4-digit resolution and an accuracy of up to 0.25%. Optional accessories, including a test fixture that provides fast connections for components of all shapes and sizes and a shielded 4-wire test cable, further increase the speed of component testing.

Circle (82) on Reply Card

### Prototyping station

Global Specialties has announced the PB-503 Proto-Board.



It is a complete electronics prototyping station that has a large 3-socket breadboarding area and such conventional support features as a function generator, a variable output power supply and 8-LED logic indicators.

Also built into the PB-502 are frequently used circuit components: debounced push buttons, 8-position DIP switch, SPDT switch, 1k $\Omega$  and 10k $\Omega$  pots, a speaker and two BNC connectors. Everything is connected to the breadboarding area through a PC board.

Circle (83) on Reply Card

### 1MHz high voltage probe

TPI's probe is designed for both oscilloscopes and multimeters. Proper impedance is selected by a 2-position switch: 1MΩ for scopes and 10MΩ for multimeters. Maximum

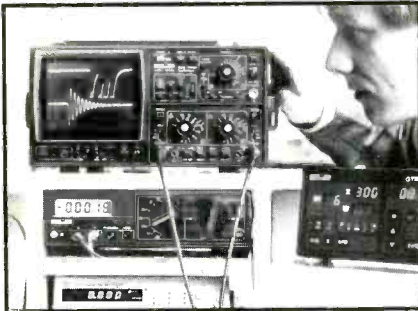


input is 15kVp-p, derating to 400V at 1MHz. The probe is 10.5 inches long with a 5-foot cable.

Circle (84) on Reply Card

### Digital storage oscilloscope

Model M6011 digital storage oscilloscope is available from BBC-Metrawatt/Goerz with a sampling rate of 20MHz for one channel or 2x10MHz for two channels. It has a storage capacity of 4kbyte with 8-bit resolution. The M6011 offers



a roll-, refresh-, single- and X-Y mode and four steps of pre-trigger up to 100%. Sweep factors are from 10ms per division through 50s per division. An analog output is standard that provides for three selectable output speeds.

Circle (85) on Reply Card

### Multifunction DMM

A 4½-digit true rms digital multimeter that provides frequency, temperature, relative dBm measurement capability in addition to volt, ohm and amp measurements has been introduced by B&K-PRECISION, Industrial Products Group, Dynascan Corporation.

Designated model 2820, the handheld DMM features 0.04%



DCV accuracy; true rms reading; 10μV resolution; peak and data

hold; diode and audible continuity tests.

Circle (86) on Reply Card

### Palm-size pliers

GC Electronics has added Palm Grip Pliers to its line of electronics-oriented products. Designed in six most commonly used sizes, this palm-fitting tool is fashioned of machined stainless steel. The lightweight handles are spring-loaded, molded for easier control during use, and color-coded for faster identification.

Circle (87) on Reply Card



CALL TOLL FREE

Include work address and phone number for Free Catalog.

800-824-2873

### SCOPES

#### IWATSU



- All 14 models in stock
- 2-3 year warranties
- 20-250 MHz

MODEL	PRICE
5702	\$ 535
5705	\$ 899
5710	\$1245
5711	\$1695
7506	\$ 749

#### HITACHI V-222

Portable Dual Trace Scope

**SALE \$535**

LIST \$715<sup>00</sup>



- DC-20 MHz
- 3-Way Power Supply
- Lightweight
- High Sensitivity and Fast Sweep Timer

#### HITACHI Hitachi Denshi America, Ltd.

- All 20 models in stock
- 2-3 year warranties
- 20-100 MHz

MODEL	PRICE
1050	\$1299
509	\$1199
VC 6041	\$4400
422	\$ 690
1100	\$1900
650	\$ 930
V209	\$ 725
1070	\$1595
1100A	\$2490
V222	\$ 550

### DIGITAL MULTIMETERS

#### BECKMAN

Beckman Industrial

- All 300, HD, and Circuitmate series
- All accessories in stock

MODEL	PRICE
HD100	\$169
HD110	\$189
HD130	\$239
HD140	\$259
300	\$120
310	\$145
320	\$179
330	\$219
350	\$229
360	\$289
4410	\$239

#### FLUKE FLUKE

- Autorange
- Touchhold function
- 0.3% accuracy
- Heavy duty  Analog display

MODEL	PRICE	MODEL	PRICE
73	\$ 79	75	\$ 99
21	\$ 99	23	\$145
25	\$229	27	\$259
8010A	\$279	8012A	\$359
8020B	\$199	8022B	\$154
8024B	\$249	8050A	\$389

#### FLUKE 77

**SALE**

**\$114**

LIST \$139<sup>00</sup>



Analog/Digital Multimeter

### POWER SOURCES

#### POWER DESIGNS

- Low and high voltage power sources
- 1-5 year warranties

MODEL	PRICE
2020B	\$750
2K20	\$695
4050	\$660
6150	\$725
TW5005W	\$595
TW6050A	\$880
TW347	\$695
TP340	\$750
TP343A	\$795

**USED TEST EQUIPMENT, TOO!—OVER 3,000 MODELS AVAILABLE AT HUGE DISCOUNTS WITH WARRANTIES!**

■ Quantity Discounts Available ■ Dealers Welcome ■ Freight and Tax Extra ■ Immediate Availability of Equipment

**United States Instrument Rentals, Inc.**

A U.S. Leasing Company  
2988 Campus Drive  
San Mateo, CA 94403

Circle (31) on Reply Card

A while back, *ES&T's* editor gave me an assignment. "Write something about audio specifications," he said. OK, I thought, that's easy enough. But then he added, "And make it interesting!" So much for easy! The subject has been treated hundreds of times in other magazines. What's left to say that would be different or exciting?

Let's think about it a minute. What is a specification? It's a number that presumably describes some facet of a unit's performance. These numbers should allow us to compare machines to discover which one best meets our needs. However, increasing sophistication of even inexpensive audio gear means we're often quibbling over a few inaudible ten-thousandths of a percent.

This, of course, does not dissuade advertisers from promoting products with numbers, although the specification-as-advertising-tool concept is not nearly as prevalent as 10 years ago, during the *power wars* that resulted in FTC regulation of audio amp testing. Back then, it seemed, even the cheapest "brown goods" amplifiers were rated with a bandwidth from dc to daylight, and a power output of 200W IPP-ILS (instantaneous peak power if lightning strikes).

Equipment reviewers of that era may have been reminded of the words of Benjamin Disraeli, 100 years earlier, who divided falsehoods into three categories, "lies, damned lies and statistics (specifications)." The tough restrictions demanded by the FTC quieted most of the outrageous claims.

Because of an overall increase in the electronic quality of components, many specifications, which were useful in past years, no longer help us distinguish the good from the mediocre. In general, for totally electronic components, such as amplifiers and receivers, THD (total harmonic distortion), IM (intermodulation distortion), S/N (signal-to-noise) ratio, and frequency response fall into this category. The same is true for receiver sensitivity, stereo separation, capture ratio, image rejection and a half-dozen others.

So let's restrict this discussion to the less well advertised specs, ones that do help us distinguish one unit from another. This is by no means an exhaustive treatment, and if I leave out your favorite number, I'm sorry.

### Power amps

This section of an audio system can be totally separate, in its own enclosure, or built into a receiver or integrated amp. As one might expect, the significant specification is *power*. How much do you need? Just enough to get your music as loud as you like, without driving the amp into clipping.

In general, too much power is better than too little, since most of the speaker damage I see has been caused by overdriving an underpowered amp. This produces distortion with a large harmonic component at high frequencies, which sometimes blows the tweeter's voice coil open. As a rule of

thumb, you'll need around 20W to 30W for easy-listening or background music, and 70W to 100W if you're looking for concert levels. To put things in perspective, remember that doubling the power results in only a 3dB higher output, which is difficult to detect. All things being equal, a 40W amp will sound only slightly louder than a 20W unit.

What about distortion? A high quality speaker seldom has distortion of less than a percent or two. Even an inexpensive amp is likely to be rated at less than 0.1%THD (total harmonic distortion). The amp is at least an order of magnitude (10 times) better than the speaker. Which do you think will predominantly affect the sound quality?

When people start talking stereo, they almost always begin with power and THD. I guess you call these *high-profile* specifications. Probably, in the consumer's mind, the concept of power pretty much determines the quality of everything from cars to computer software. THD tells you how *clean* the sound is, another consumer fetish. Partly for this reason, manufacturers always want you to have a nice, expensive distortion analyzer if you do warranty work for them. Included in this instrument are an ultra-clean sine wave generator, a voltmeter, a distortion meter. I've worked the repair bench for 13 years, and my opinion of a THD analyzer is that it's great for catching dust.

It didn't used to be that way. When I started, every unit I completed got a full THD test. That experience convinced me how unnecessary it was. Almost any failure in an audio circuit will produce gross symptoms. Usually the unit is dead. The few times it's distorted, the problem is easily observable on an oscilloscope. Assuming you've adjusted the bias properly, if you can run a unit at full power, into loads, and get symmetrical clipping of the negative and positive peaks of the waveform, it's OK. For my money, I'd rather have a good swept-function generator and spend what's left on something useful, like a "Z" (impedance) meter. But, if you want to be a warranty station . . .

Input sensitivity is a commonly ignored, yet relevant specification. It tells you how much of a signal you must feed into an amp at the various inputs, in order to produce full output. For example, if the input sensitivity of an amp's tape input is 150mV, you must be sure that the tape deck you use can produce at least this much output voltage. You'll see what I mean when you're trying to match a phono cartridge to an amp. If you connect one with an output of 2.5mV to an amp with a sensitivity of 4mV, you may not be able to get full power with the phonograph. Furthermore, the voltage at the tape outputs may be too low.

When you are troubleshooting a case of low gain, it's helpful to have sensitivity figures handy. Likewise, when you've decided to trade some hard-won cash for a stereo system, you need to be sure that input and output levels are compatible. **ES&T**

# Photofact

These Photofact folders for TV receivers and other equipment have been released by Howard W. Sams & Co. since the last report in ES&T.

## AOC

Chassis M3C2-1B2 (Runs 13 thru 16) ..... 2404-1

## AOC

Chassis M9C2-7K, M9C2-8K1 (Run 10) ..... 2406-1

## EMERSON

MT1310 ..... 2407-1

## EMERSON

EC-193, EC-193A ..... 2410-1

## GOLD STAR

CMX-4120 ..... 2405-1

## MAGNAVOX

Chassis 25C401 thru 25C406 ..... 2410-2

## QUASAR

Chassis AQDC110, ARDC110 ..... 2407-2

## RCA

Chassis CTC126C ..... 2408-1

## SANYO

Chassis A4L-70000 ..... 2408-2

## SONY

Chassis SCC-548ZA ..... 2409-1

## SYLVANIA

Chassis 13C301/02/03/04/05/06/07/09/  
11/12/13/14/15 ..... 2404-2

## SYLVANIA

Chassis 19C301 thru 19C314 ..... 2405-2

## SYLVANIA

RXC192SL02 ..... 2406-2

## SYLVANIA

RAD138WA01, RAE138WA01 ..... 2409-2

## COMPUTERFACTS

### AMDEK

Color 300 ..... CMT10-1

### AMDEK

Color 600, 700, 710 ..... CMT10-2

### APPLE

A2M2010 ..... CMT9-1

### SANYO

AVM-255 ..... CMT9-2

### SANYO

MBC-550, MBC-555 ..... CSCS11

### STAR

DELTA-10 ..... CP19

# Classified

Advertising rates in the Classified Section are 75 cents per word, each insertion, and must be accompanied by payment to insure publications.

Each initial or abbreviation counts a full word.

Minimum classified charge is \$15.00.

For ads on which replies are sent to us for forwarding (blind ads), there is an additional charge of \$25.00 per insertion to cover department number, processing of replies, and mailing costs.

Classified columns are not open to advertising of any products regularly produced by manufacturers unless used and no longer owned by the manufacturer or distributor.

## FOR SALE

**AUTOMOBILE RADIO** and tape replacement parts. Delco, Chrysler, Philco-Ford, Motorola, Panasonic and many others. Large inventory. Laran Electronics, Inc., 3768 Boston Road, Bronx, NY 10469. (212) 881-9600. National (800) 223-8314, NY State (800) 446-4430. 1-85-tfn

**BOOTLEGGERS BIBLE** for CB Modification \$12.95, CB Radio Repair \$10.95. Linear Amplifier Planbook \$14.95, kits, etc. Catalog \$1.00 refundable—APS, POB 263 Newport, R.I. 02840 401-846-5627. 12-84-tfn

**SCRAMBLED TELEVISION**, encoding/decoding. New book. Theory/circuits, \$9.95 plus \$1 shipping. Workshop, Box 393ES, Dept. E, Bethpage, NY 11714. 1-85-tfn

**TV TROUBLE ANALYSIS TIPS.** Over 300 symptoms/ remedies by circuit area; tough ones over the years. Save time and money. Send \$12.50 to CHAN TV, 8151 Grandview Rd., Chanhassen, MN 55317. 1-85-tfn

**CABLE CONVERTERS.** Lowest price. Dealer inquiries accepted. Quantity Discounts. FREE CATALOG. P.G. Video Corp, 61 Gatchell St., Dept. ES&T, Buffalo, NY 14212. 5-85-tfn

**CABLE TV CONVERTERS & EQUIPMENT.** Plans and parts. Build or buy. Send S.A.S.E. C&D Electronics, P.O. Box 1402, Dept. ES&T, Hope, Arkansas 71801. 1-86-tfn

**DISCOUNT CATV** converters/decoders and video accessories. Solar cells for remote power and battery charging applications. Send for free information and prices—it could save you big money on your next purchase of these and other CATV items. Easy View, P.O. Box 221, Arlington Heights, Illinois 60006. (312) 952-8504. Ask for Rudy Valentine. 06-86-1t

**TV SYMCURES.** Over 100 current symptoms and cures compiled from repairs done in past 6 months. Send \$6.95 to Sun Electronics, P.O. Box 9553, Columbia, S.C. 29290. 06-86-1t

**VIDEO TUNE-UP** disk converts the Commodore 64/128 into a full function video analyzer. Produces all standard test patterns (color bars, crosshatch, centering...etc.) plus the latest **BAR SWEEP** pattern. Instructions included \$39.95. SOLAS PRODUCTS, Box 665, Springhouse, PA 19477. Dealers call (215) 723-4597. 06-86-1t

**SERVICE MANUALS WITH SCHEMATICS** for Atari 800XL, Atari 1050, or Atari 520ST sale priced only \$17.50 each (add \$2.00 shipping). CALL (805) 927-4667 VISA/MC/COD or send to: Electronic Dimensions, P.O. Box 1846, San Luis Obispo, CA 93406. Free Catalog. 06-86-1t

**"\$500.00 Worth"**—top quality radio, TV parts, only \$50.00. CX130, SG-274, PA-501, transistors, ICs, others, save!! Order from: Dependable TV, Box 1645, C'sted, St. Croit, V.I. USA 00820. 06-86-2t

**FOR SALE: DIEHL MARK V ANALYST.** 608-238-4629 06-86-1t

**INDIVIDUAL PHOTOFAC FOLDERS** (not sets) #1 to #1400, \$3.00 first-class postpaid. Loeb, 414 Chestnut Lane, East Meadow, NY 11554. 4-86-3t

**REPAIR OF ZENITH CIRCUIT BOARD 9-160-ALL;** with dud exchange \$33.00. One year guarantee. Kiniral Electronics, 68-26 64th Place, Glendale, N.Y. 11385. (718) 366-3859. 4-86-3t

**TV TROUBLESHOOTING:** Over 100 ILLUSTRATED problems-solutions of difficult repairs. Also, 12 steps to easier TV repair, \$12.00. **REMARKABLE DIAGNOSTIC TOOL:** Determine operation of high voltage circuits every time. You will not be mistaken about your conclusions, \$5.00. Jones, Box 702, Niceville, Fla. 32578. 5-86-6t

**FOR SALE.** Northern Minnesota. Complete Television Service Shop and Building. Retiring. Established 35 years. Excellent reputation. Asking \$40,000. Great future for ambitious person. P.O. Box 872, Hibbing, Mn. 55746. 6-86-1t

## BUSINESS OPPORTUNITIES

**3 HRS FROM SAN FRANCISCO** in pine forested foothills, electronic repair business. Poor health forces sale. Bldg./shop/equipmt. & 7 rm. residence w/lg. garden, was \$165K, now \$155K. (916) 872-1962. 12/85tfn

**T.V. SALES & SERVICE.** Well established business located northern Virginia. Owner retiring and will help with financing. Call 703-972-7027 after 7:00 p.m. EST. 06-86-6t

**ONE MAN,** cash & carry electronic repair business, inventory & equipment. Small recreational town in Idaho. Ten years plus in business. Owner wishes to retire. \$15,000 208-756-2916, Box 488, Salmon Id. 83467. 06-86-1t

**ALABAMA OPPORTUNITY.** 1 acre fenced with 2400 sq. ft. bldg. Electronics shop and music store combo. Very econo-operation, excellent opportunity in warm, friendly south. Money maker, sacrifice \$50,000. Call Tommy, 205-295-8633. 06-86-1t

## Bus. Opportunity (Cont.)

**BARGIN OF THE YEAR** (40% of true value) TV-Video sales & service owner must sell due health and age. Have five, need seven employees. Book value about \$250K. Stay backlogged service work as short technical help. Major opportunity to build back up. Adjacent: Marine Corps Air Station and Naval Rework Facility, Cherry Point, N.C. One of the best equipped Service Centers in N.C. Major Brands Sales and Warranty service (14 Yrs) Excellent recreational area. Mild winters. Address inquiries to PO Box 306, Havelock, N.C. 28532. Phone 919-447-7242. Asking \$125K (Sacrifice Price) WILL ASSIST in TERM financing.

06-86-1t

## HELP WANTED

**CAMERA-VIDEO** Technicians needed. Top pay and benefits for well trained and experienced technicians who are expert with consumer and/or industrial cameras and VCR's. Training by manufacturers such as Sony, Hitachi, Panasonic, etc., are necessary for job experience. Come to sunny Florida and enjoy your work & leisure time. Write or call ATLANTIC ELECTRONICS INC., 1881 NE 26 St., Ft. Lauderdale, FL 33305. (305) 564-8274 10 AM to 6:30 PM. Ask for Dave or Joe. 8-85-tfn

**VIDEO/AUDIO** technician needed. Top pay and benefits for well trained and experienced technicians who are expert with consumer TV and audio equipment. Training by manufacturers such as: Sony, Hitachi, RCA, Panasonic, etc. are necessary for job experience. Write or call: Atlantic Electronics, Inc., 1881 NE 26th St., Ft. Lauderdale, FL 33305, 305-564-8274 (10 AM 6:30 PM). Ask for Dave or Joe. 06-86-tfn

## EDUC.-INSTRUCTION

**UNIVERSITY DEGREES!** Economical home study for Bachelor's, Master's, Doctorate. Prestigious faculty counsels for independent study and life experience credits. Free information—Richard Crews, M.D. (Harvard), President, Columbia Pacific University, 1415 Third St., Dept. 2B86, San Rafael, CA 94901; Toll Free: 800/227-0119; California: 800/552-5522; or 415/459-1650. 06-86-1t

### DANDY-DAPTER™

PATENTED CRT ADAPTER—Don't buy another socket for your CRT Tester! This is the **Only** way you can win the Socket War! Guaranteed to fit your tester & allow you to test/clean/restore ANY Color, B/W Projection, Scope or Camera CRT's. Visa/M-Card. Checks. CDDs. New Low Price \$59.95 (We pay UPS) 1(800) 331-9658 DANDY ELECTRONICS, 2323 GIBSON, MUSKOGEE, OK 74403



Circle (33) on Reply Card

**Tech's Guide To Pricing**  
updated new 5th edition... a framework for setting rates that apply to Hi-Tech products... a formula that guarantees SUCCESS!  
Call Toll Free for details **1-800-228-4338** 8/5 CST

Circle (34) on Reply Card

**NATIONAL REBUILT HEADQUARTERS**  
**SONY**  
**REBUILT PICTURE TUBES**  
**2 YR. WARRANTY—**  
**FREE U.P.S. DEL. 716-621-5250**

Circle (35) on Reply Card

**ATTN. SERVICE SHOP OWNERS**  
Are you serious about improving your operation? We offer workable solutions from one of the most respected service management consultants. 16 years of professional experience solving the problems for major companies.  
**MANAGEMENT INSIGHT**  
R. J. SEBRING  
4511 17TH AVE. W.  
BRADENTON, FL 33529  
(813) 792-3804

Circle (36) on Reply Card

# Advertisers' Index

	Page Number	Reader Service Number	Advertiser Hotline
Automated Production Equipment Corp.	53	25	516/654-1197
Beckman Industrial Corp.	55	26	714/671-4800
Caig Laboratories, Inc.	59	28	619/743-7143
Chemtronics, Inc.	9	7	800/645-5244
Cleveland Institute of Electronics	14A-14B		800/321-2155
Cleveland Institute of Electronics	15	9	800/321-2155
Dandy Mfg. Co.	66	33	800/331-9658
Diehl Engineering	21,23,25	12	806/359-0329
Digitron Electronic	57	27	800/526-4928
ETA	52		
Fluke, John Mfg. Co., Inc.	7	6	800/227-3800
Fordham Radio Supply Co.	51	22	800/645-9518
Leader Instrument Corp.	IFC	1,2	516/231-6900
Management Insight	66	36	813/792-3804
MCM Electronics	IBC	3	800/543-4330
NAP Consumer Electronic Corp.	3	4	615/639-1121
NESDA	57		817/921-9061
Nippon American Inc.	53	24	800/327-7522
NTE Electronics, Inc.	17	10	800/631-1250
Optima Electronics	61	29,30	800/327-0224
Precision Picture Tubes	66	35	716/621-5250
Projector Recorder Belt Corp.	50	21	800/558-9572
PTS Corp.	49	19	812/824-9331
RCA Distributor and Special Products	18-19	11	
RCA Distributor and Special Products	27	13	
Sencore, Inc.	39,41	15,16	800/843-3338
Sencore, Inc.	43,45	17,18	800/843-3338
Simpson Electric Co.	13	8	312/687-2265
Spectrum 2000 Inc.	59	38	800-922-6333
Sperry AW Instruments Inc.	5	5	800/228-4338
Sperry Tech, Inc.	66	34	800/228-4338
Synchronicity Research Company	52	23	405/628-3695
U.S. Instrument Rentals	63	31	800/824-2873
Viz Test Equipment	29	14	800/523-3696
Wahl Clipper Corp.	50	20	815/625-6525
Zenith	BAC		

**ELECTRONIC SERVICING & TECHNOLOGY** Volume 6, No. 6 (USPA 462-050) is published monthly by Intertec Publishing Corp., 9221 Quivira Road, P.O. Box 12901, Overland Park, KS 66212. Second Class Postage paid at Shawnee Mission, KS, and additional mailing offices. POSTMASTER: Send address changes to ELECTRONIC SERVICING & TECHNOLOGY, P.O. Box 12952, Overland Park, KS 66212-9981.

**Use ES&T  
classified  
ads**

# ARTICLE REPRINTS

Interested in ordering custom reprints of an article from this issue? Reprints of articles about your company or products can be valuable sales and marketing tools. For information, call or write Kelly Hawthorne, Intertec Publishing Corp., P.O. Box 12901, Overland Park, Kansas 66212; (913) 888-4664.

\*minimum order 1,000 copies

# More Than Just A Catalog

# MCM

## Catalog #12 Now Available

You'll be amazed at the many new products in the latest edition of the MCM Electronics Catalog. Over 400 new items have been added to what is already one of the finest lines available from one source. But our company is more than just a catalog!

We're people serving people and fast, friendly service has become our trademark! Depend on us to take that "extra" step that ensures your complete satisfaction. Low prices, fast shipment, volume discounts, plus nationwide TOLL-FREE lines ...

## You'll find it all at MCM!



Call TODAY for our newest Catalog!

TOLL-FREE, 1-800-543-4330

In Ohio, 1-800-762-4315 In Alaska and Hawaii, 1-800-858-1849



MCM ELECTRONICS

A PREMIER COMPANY

858 E. Congress Park Drive  
Centerville, OH 45459

SOURCE NO. ES&T-10

**Chances are the easiest, fastest, most rewarding way for you to get plus business is by selling Zenith Audio and Video Accessories to the same customers whose electronics you now service.**



Like all Zenith products, Zenith Audio/Video Accessories are made to meet or exceed quality and performance standards that have earned Zenith a level of acceptance in the marketplace unsurpassed by any brand name in the consumer electronics industry.

And it goes without saying that the better known and the more respected a product's name the easier, faster, and the more profitably you can sell it across the counter...or while you're out of the shop on a service call.

Call your Zenith distributor's Accessory Sales Manager and learn how to turn some 6, 7 or 8 feet of floor space (or even your caddy) into a new Zenith Profit Center.



The quality goes in before the name goes on.®

It's all there! Yours for the asking! The help and expertise of your Zenith distributor's Accessory Sales Manager and the selling power of the Zenith name on these top-performing video and audio accessories!

You bet you can make it big – and even bigger in the electronics business – by selling Zenith Audio and Video Accessories to the same customers whose electronics you now service!

Call your Zenith distributor's Accessory Sales Manager now or write direct for the name of the Zenith distributor serving your area.

Wait no longer. Call or write now!